

Contents

1 1+n technology

System description	3
--------------------	---

2 Safety remarks

Danger	3
--------	---

3 Configuration, conductor lengths

1+n technology	4
----------------	---

Overview	6
----------	---

4 Device overview

Door loudspeakers, call buttons	8
---------------------------------	---

Power supply, line rectifiers	10
-------------------------------	----

Switching, control	12
--------------------	----

In-house telephone	14
--------------------	----

Accessories	15
-------------	----

5 Installation

General information	16
---------------------	----

Siedle Vario with IQ HTS	18
--------------------------	----

Siedle Vario	20
--------------	----

Siedle custom-fit door loudspeaker	22
------------------------------------	----

Siedle Classic	24
----------------	----

Siedle Steel	26
--------------	----

DoorCom Analog DCA 612-...	28
----------------------------	----

Siedle Vario 2 door stations	30
------------------------------	----

Siedle custom-fit door loudspeaker with 2 door stations	32
---	----

Siedle Vario 3 door stations	34
------------------------------	----

Siedle Vario, internal speech communication	36
---	----

Siedle Vario 1 main door station, 1 storey door station	38
---	----

Siedle Vario 1 main door station, 1 storey door station, internal speech communication	40
--	----

Siedle Vario, group switching with internal speech communication	42
--	----

6 Supplementary functions

Group controller GC 612-...	44
-----------------------------	----

Switching/remote controller SFC 602-...	46
---	----

Storey controller ETC 602-...	48
-------------------------------	----

Secondary signal controller NSC 602-...	49
---	----

Controller door release CTÖ 602-...	50
-------------------------------------	----

Parallel switching in-house telephones	52
--	----

Pilfer safeguard DSC 602-...	53
------------------------------	----

Staircase light/Outside light	54
-------------------------------	----

LED actuation, potential-free buttons	55
---------------------------------------	----

Exchange/extension	56
--------------------	----

7 Servicing

Measured values	58
-----------------	----

8 Glossary, Index	59
--------------------------	-----------

1 1+n technology

System description

Configuration

The wire-saving 1+n system is based on an installation with a common core and a call core "n" for each user which links the bell button at the front door directly to each in-house telephone. Using these two cores, all the functions are implemented, i.e. ringing, speech, door release and switching functions. Up to door 8 door stations can be operated in parallel without the need for any further accessories.

At each in-house telephone, a storey call button can be connected which allows direct calls to be placed to the apartment door. Actuation of the door release always takes place for the door station from which the door bell was pressed. There is one speech channel available within the 1+n system; The number of speech channels can be increased by adding further controllers.

In the plans, the joint core is laid to terminal 1 and the calling core "n" to terminal 7. Both cores must be routed within the same cable. Terminal 7 is supplied with power in its idle status via the call button module with direct voltage. As long as the call button remains depressed, the voltage continues to rise to its full value.

No programming is required for the basic functions ringing, speech, door release.

2 Safety remarks

Danger



Mounting, installation and servicing work on electrical devices may only be performed by a suitably qualified electrician. Failure to observe this regulation could result in the risk of serious damage to health or fatal injury due to electric shocks.

- When working at the device, observe the remarks relating to mains cut-off.
- Operation at an altitude of up to 2000 m above sea level.
- Observe EN 62368-1!

In a building installation, an all-pole mains switch with a contact opening of at least 3 mm must be provided. The device must not be exposed to water drops or sprayed water! Sufficient ventilation must be ensured. Pay particular attention to ensure that ventilation slots are not covered.

- Ensure maximum fusing of 16 A for the mains connection in the building installation.
- When planning large-scale (complex) systems, the distributor space required for the switch panel mounting devices must be taken into consideration in the distributor planning process.
- No external voltages >30 V AC/DC may be applied to system users.

Devices with 230 V connection

In accordance with DIN VDE 0100 part 410, section 411.1.3 attention must be paid to ensuring a safe separation between system lines and the mains voltage; i.e. system and mains cores must not be permitted to touch! The system line cable (extra-low safety voltage) must be stripped back by the minimum possible.

3 Configuration, conductor lengths

1+n technology

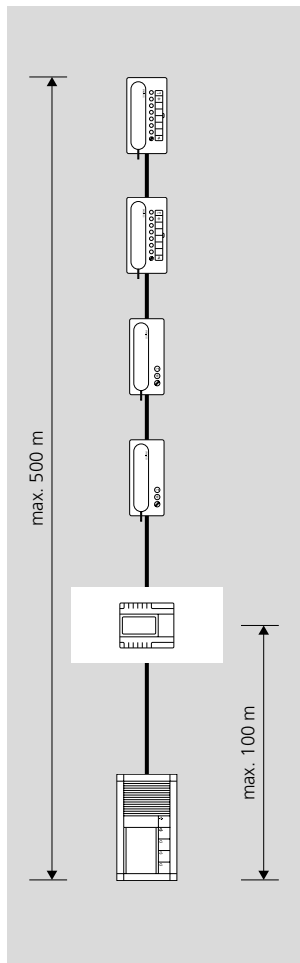

Configuration of the 1+n system

The basic installation is performed as a side circuit installation. The door stations and in-house telephones are routed to the sub-distributor. Installation can be performed as a star, tree or bus structure.

The door station and in-house telephones are linked by means of terminals 1 and 7. The side circuit cores are routed to terminal 1 (- potential), the calling cores to terminal 7. Terminal + is used as a reference terminal for the apartment bell button ERT and to supply the three-tone chime (terminal G) of the deluxe in-house telephone.

Jumpers are inserted within the door station to link the door loudspeaker terminal block and the terminal block of one or more call button modules. Jumpers are inserted between terminal 6 and 6, terminal 11 and 11 and terminal + and + for all call button modules. Where there are several door stations, from the second door station the jumper between + and + to the call button module is only required at one door loudspeaker. Depending on the door loudspeaker used, terminals b and c should be bridged differently.

Functional characteristics

The bias current to terminals 1 and 7 is 18 V DC. When pressing the bell button, the voltage rises to 24 V DC and then drops to around 15 V DC. After picking up the receiver, a speech connection is created between the door station and the in-house telephone.

For 30 seconds after replacing the receiver, the speech connection can be re-established by lifting the receiver again. The system then returns to idle voltage and the audio privacy device is activated. The audio privacy device ensures that a call can only be accepted at the in-house telephone at which the front door-bell rang.

Functions

- Door call: Ringing at the front door (door station) and speech connection
- Storey call: An apartment bell (ERT) can be connected to each in-house telephone
- Door release: Pressing the door release button at the in-house telephone switches the DR contact in the door loudspeaker module to terminal c, duration fixed at 3 seconds
- Light switching: Pressing the light button at the in-house telephone switches the Li contact in the door loudspeaker module to terminal c, duration fixed at 0.8 seconds

Other functions are possible using additional controllers:

- Group controller: Permits internal speech operation between 6 in-house telephones or parallel switching of up to 6 in-house telephones at one bell button
- Storey controller: permits the connection of door stations to one or more storeys
- Switching and remote controller permits switching and control functions via the in-house telephones
- Door release controller: takes care of tamper-proof operation of the door release

Power supply

The line rectifier NG 602-... supplies the door station with the following voltages:

Terminal assignment

+, -	Supply voltage 24 V DC
b, c	Power supply 12 V AC

Conductor length

Conductor material J-Y(St)Y or YR conductor with 0.8 mm diameter:

- max. 500 m/1640 ft between the door station and the most distant in-house telephone
- max. 100 m/328 ft between the line rectifier and the most distant door station
- max. 500 m/1640 ft core length TLn between several door stations

Conductor material J-Y(St)Y or YR conductor with 0.6 mm diameter:

- max. 250 m/820 ft between the door station and the most distant in-house telephone
- max. 50 m/164 ft between the line rectifier and the most distant door station
- max. 250 m/820 ft core length TLn between several door stations

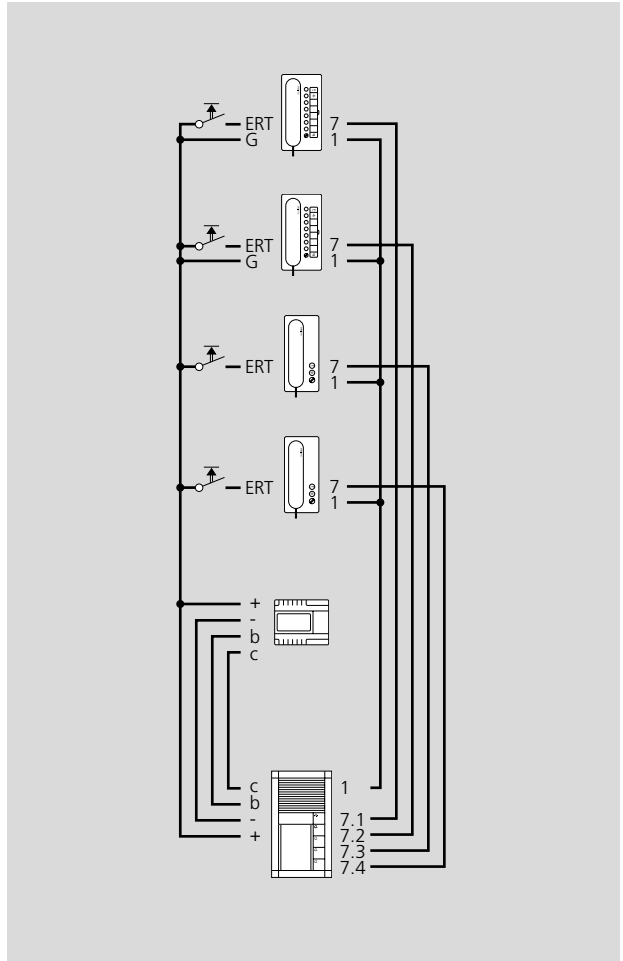

3 Configuration, conductor lengths

Overview

Parallel door stations

Up to 8 door stations can be connected in parallel without the need for any further accessories. The door loudspeakers become synchronized one with the other via terminals TLn.

Parallel in-house telephones or accessories

Up to 2 in-house telephones can be operated in parallel, e.g. HTS 811-... and HTC 811-... The GC 612-... enables up to 6 in-house telephones to be rung in parallel via one call button. Secondary signal unit NS 711-... and secondary signal controller NSC 602-... count as parallel devices.

Storey call

Every in-house telephone has a terminal ERT for a storey call button. The storey call button (ERT) is used for ringing at the apartment door.

Storey door station

Instead of a storey call button ERT a door station is also possible on a storey. To connect a storey door station, the storey controller ETC 602-... is required.

Internal speech

Speech is possible between the in-house telephones HTC 811-... For this function, the controller GC 612-... is required

Control function

Switching and control functions can be initiated from the deluxe in-house telephone HTC 811-... For the implementation of control functions, the switching/remote controller SFC 602-... is required. Buttons 5 and 6 can be used as potential-free buttons. The buttons can be made potential free using a DIL switch in the in-house telephone. Pick-up at terminals T5/T5 and T6/T6.

Connection of the telephone system

One or more door stations using 1+n technology can be connected using the DoorCom Analog DCA 612-... to the analogue PBX extension of a telephone system. Up to three call buttons can dial a PBX extension in the telephone system or a telephone number. Dialling takes place using the dual tone multiple frequency method DTMF.

Door release

Every door loudspeaker has an integrated relay to actuate a door release. The relay contact switches the door release button in the in-house telephone on actuation for 3 seconds. It only switches the door release of the door at which the bell was rung. To ensure tamper-proof switching of the door release, the door release controller CTÖ 602-... has to be used.

Name plate lighting

The call button modules and the info module are equipped with LED lighting. The current consumption of a module amounts to max. 20 mA.

Door station light button

The door loudspeaker module TLM 612-... has a relay for actuation of an outdoor light. The contact T1 to T2 switches when the light button in the door loudspeaker is actuated for as long as the light button remains depressed.

In-house telephone light button

Each in-house telephone has a light button to actuate a joint staircase or entrance light. Evaluation of the contact takes place in the door loudspeaker module. On actuation of the light button at the in-house telephone, the relay contact switches for 0.8 seconds from terminal c to Li. Where there are several doors, the relay contact switches at the door station from which the last call was made.

Secondary signal unit

A secondary signal unit NS 711-... can be connected in parallel to an in-house telephone in order to additionally signal the call in another room. A maximum of 1 secondary signal unit can be connected to an in-house telephone.

Secondary signal controller

Using the secondary signal controller NSC 602-... a potential-free contact can be made available each for the door and storey call, e.g. to actuate a radio-controlled chime.

4 Device overview

Door loudspeakers, call buttons

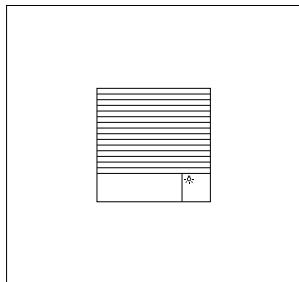

TLM 612-02

Door loudspeaker module 1+n technology for Siedle Vario with integrated loudspeaker and microphone. Performance features:

- Front grille made of weather and UV-resistant polycarbonate
- Loudspeaker, voice volume can be adjusted
- Durable electret microphone
- Potential-free light button with LED-lit light symbol
- Work contacts for light and door release, can be controlled without additional wiring via existing side circuit
- An SFC 602-... switching/remote controller and/or CTÖ 602-... controller door release can be connected
- A COM 611-... code lock module and/or DRM 612-... display call module for digital call input can be connected
- Acoustic feedback when pressing a call button can be activated

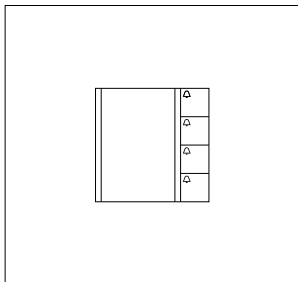

TM 612-1 to -4

Call button module for wire-saving 1+n system. 1-4 call buttons, integrated LED lighting, connection via terminal block. Supply to the LED lighting via terminal b and c with 12 V AC, current consumption 20 A per call button module TM 612-...

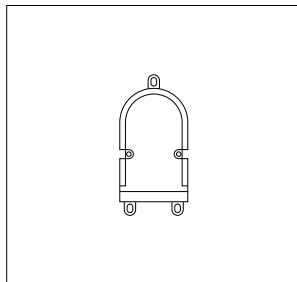

TLE 061-01

Custom-fit door loudspeaker 1+n technology for installation in on-site intercom compartments, door constructions, letterboxes, etc.

Performance features:

- Loudspeaker, voice volume can be adjusted
- Durable electret microphone
- Potential-free work contacts for light and door release, can be controlled without additional wiring via existing side circuit
- An SFC 602-... switching/remote controller and/or CTÖ 602-... controller door release can be connected
- Universal fastening options, when used with the ZJ 051-... grille, it can be screwed onto this directly

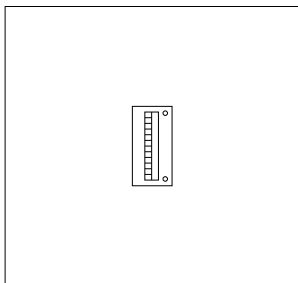

ZD 061-10

Accessory diodes for connecting 10 of the customer's call buttons to the TLE 061-... custom-fit door loudspeaker.

An accessory diode ZD 061-10 is required for each started group of 10 call buttons.

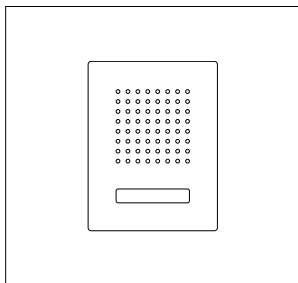

Siedle Classic

Door station with stainless steel front. Door loudspeaker and illuminated call buttons. Integrated door release contact (TÖ), contact load max. 15 V AC, 30 V DC, 2A, switching time TÖ fixed at 3 seconds. Current consumption for LED lighting of bell buttons, per button 5 mA, 12 V AC.

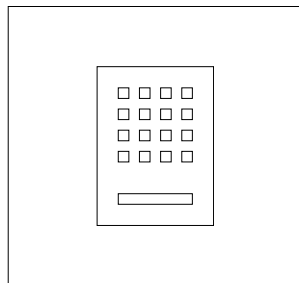

Siedle Steel

Door station with stainless steel front, door loudspeaker and call buttons. Integrated door release contact (TÖ), contact load max. 15 V AC, 30 V DC, 2 A, switching time TÖ fixed at 3 seconds. Current consumption for LED lighting of bell buttons, per button 3 mA, 12 V AC. Acoustic feedback when the call button is pressed.

4 Device overview

Power supply, line rectifiers

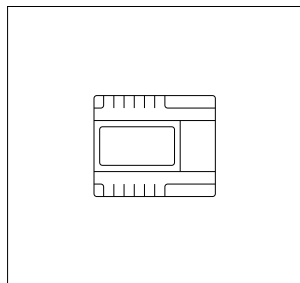

NG 602-01

Line rectifier in switch panel housing for 1+n technology, and for power supply to supplementary components. Inclusive of function LEDs.

Operating voltage: 230 V AC, +/-10 %, 50/60 Hz

Operating current: 200 mA

Output voltage: 23.3 V DC, 12 V AC

Output current: 0.3 A DC, 1.6 A AC

Fusing: primary Si1 T 200 mA L, secondary side with thermal fuse

Protection system: IP 20

Ambient temperature:

0 °C to +40 °C

Horizontal pitch (HP): 6

Dimensions (mm) W x H x D:

107 x 89 x 60

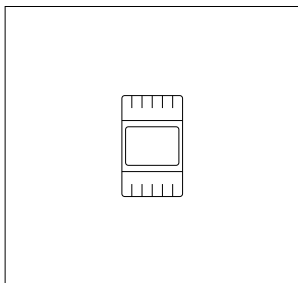

TR 603-0

Transformer in switch panel housing for supplying system and additional components.

Operating voltage: 230 V AC, +/-10 %, 50/60 Hz

Operating current: 100 mA

Output voltage: 12 V AC

Output current: max. 1.3 A

Fusing: primary thermal fuse, secondary short circuit proof

Protection system: IP 20

Ambient temperature:

0 °C to +40 °C

Horizontal pitch (HP): 3

Dimensions (mm) W x H x D:

53.5 x 89 x 60

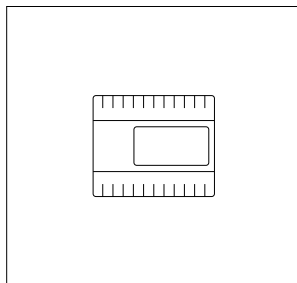

GC 612-0

Group controller in switch panel housing for internal speech operation, for connection of max. 6 in-house telephones HTC 811-... and speech connection to the door loudspeaker. Door calls can be selectively assigned.

Operating voltage: 24 V DC

Operating current: max. 300 mA

Contact type: contact 24 V, 2 A

Ambient temperature:

0 °C to +40 °C

Protection system: IP 20

Horizontal pitch (HP): 6

Dimensions (mm) W x H x D:

107 x 89 x 60

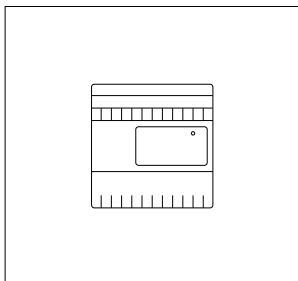

NG 706-30/33-0

Line rectifier in switch panel housing for central supply of Siedle system components.

Operating voltage: 230 V AC, +/-10 %, 50/60 Hz

Operating current: 250 mA

Output voltage: 30 V DC

Output current: 1.1 A

Fusing: secondary side with thermal fuse

Protection system: IP 20

Ambient temperature:

0 °C to +40 °C

Horizontal pitch (HP): 6

Dimensions (mm) W x H x D:

107 x 109 x 60

Note

One NG 706-30/33-... supplies a maximum of 8 IQ HTS. Alternatively, an NG 602-... can be used, this supplies a maximum of two IQ HTS.

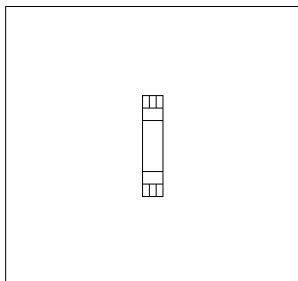

PSM 1 12 24

Line rectifier in switch panel housing for central supply of IQ in-house telephones and the bus video panel. One PSM 1 12 24 supplies a maximum of 2 IQ in-house telephones or 1 bus video panel. In systems with bus video panel, a maximum of 2 PSM may be used.

Operating voltage: 110–240 V AC, 50/60 Hz

Operating current: 265 mA

Output voltage: 24 V DC +/-3 %

Output current: 0.5 A

Fusing: T 0.8

Protection class: II

Ambient temperature:

-10 °C to +50 °C

Horizontal pitch (HP): 1

Dimensions (mm) W x H x D:

17.5 x 96 x 68

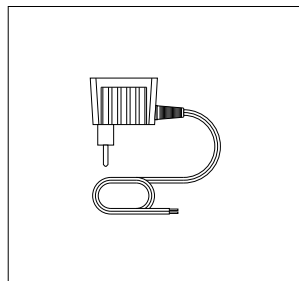

NEO006.0-I-X-12

Power supply unit for supplying one IQ in-house telephone.

Operating voltage: 100–240 V AC, 50/60 Hz

Operating current: 160 mA

Output voltage: 12 V DC +/-5 %

Output current: 0.6 A

Cable length (mm): 3000

Ambient temperature:

+5 °C to +40 °C

Dimensions (mm) W x H x D:

36 x 59 x 41

4 Device overview

Switching, control

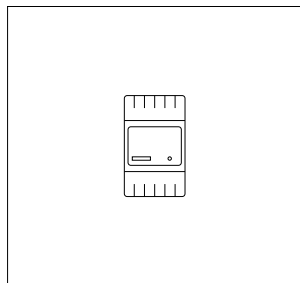

SFC 602-0

Switching/remote controller in switch panel housing for execution of max. 4 central switching/control functions (connection to DL) or 4 local switching/control functions (connection GC 612-... or door loudspeaker of the ETC 602-...).

Operating voltage: 12 V AC
Operating current: max. 250 mA
Contact type: 1 changeover switch 24 V, 2 A; 3 n.o. contacts 24 V, 2 A
Switching time: 2 x adjustable from 3 sec to 20 min and 2 x fixed at 3 sec
Horizontal pitch (HP): 3
Dimensions (mm) W x H x D:
53.5 x 89 x 60

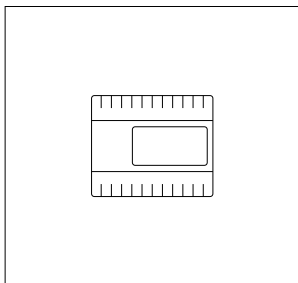

ETC 602-0

Storey controller in switch panel housing for connection of an additional storey door loudspeaker to the relevant system telephones HTS/HTC 811-...

Operating voltage: 24 V DC
Operating current: max. 60 mA
Contact type: changeover switch max. 24 V, 2 A
Ambient temperature:
0 °C to +40 °C
Protection system: IP 20
Horizontal pitch (HP): 6
Dimensions (mm) W x H x D:
107 x 89 x 60

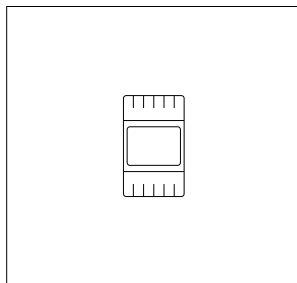

CTÖ 602-0

Controller door release in switch panel housing for actuation of a door release in conjunction with the wire-saving 1+n system. For security reasons this should not be connected directly to the door loudspeaker.

Operating voltage: 12 V AC
Operating current: max. 70 mA
Contact type: contact 24 V, 2 A
Switching time: Fixed at 3 sec
Protection system: IP 20
Ambient temperature:
0 °C to +40 °C
Horizontal pitch (HP): 3
Dimensions (mm) W x H x D:
53.5 x 89 x 60

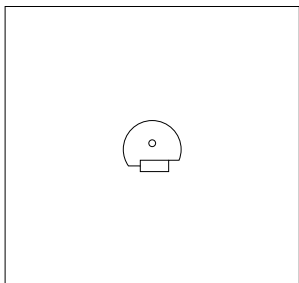

NSC 602-0

Secondary signal controller for the 1+n system, for connecting a customer-provided secondary signal unit (e.g. separate chime) with its own power supply for additional call signalling on the HTS/HTC 811-... in-house telephone.

The NSC 602-... is suitable for installation in a 55 mm-device box (e.g. under the in-house telephone) or in a junction box.

Contact type: 2 n.o. contacts, max. 24 V, 1 A

Ambient temperature:

0 °C to +40 °C

Protection system: IP 20

Dimensions (mm) dia. x H: 51 x 23

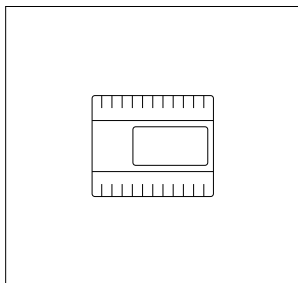

DCA 612-0

DoorCom-Analog, in switch panel housing as an interface for the 1+n technology, connects the door intercom system to telephone systems via the system's analogue connection.

Operating voltage: 12 V AC

Operating current: max. 100 mA

Ambient temperature:

0 °C to +40 °C

Horizontal pitch (HP): 6

Dimensions (mm) W x H x D:

107 x 89 x 60

4 Device overview

In-house telephone

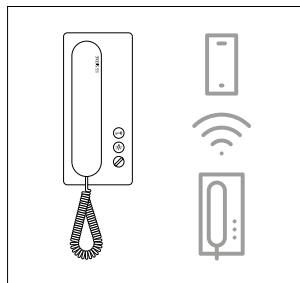

IQ HTS

In-house telephone for 1+n technology with WLAN interface for mobile extension through the Siedle app.

With the call, speech, door release and light functions on the indoor station and on a smartphone with the Siedle app.

The storey call is also available on the in-house telephone.

Performance features:

- 2.4 GHz WLAN interface for the Siedle app
- Bluetooth 4.2 interface for commissioning
- Another indoor station can be connected in parallel
- Integrated door release and light button
- Integrated audio privacy function
- Call volume up to max. 83 dB(A)
- Automatic update function when Internet connection is active
- The Siedle app behaves like an indoor device connected in parallel for the call
- A maximum of 4 iOS or Android app users can be coupled with an IQ indoor station.

Operating voltage: 12–30 V DC

Operating current: max. 300 mA

Ambient temperature:

+5 °C to +40 °C

Dimensions (mm) W x H x D:

91 x 201 x 48

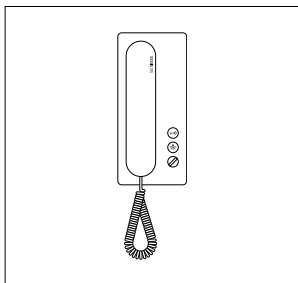

HTS 811-0

Standard in-house telephone with the functions:

- Calling, speech, door release and storey call
- Door release and light button
- Rotary controller for ringtone volume with integrated muting
- Door call as 3-tone call, storey call as 2-tone call
- Call volume max. 83 dB (A)

Ambient temperature:

+5 °C to +40 °C

Dimensions (mm) W x H x D:

91 x 201 x 46

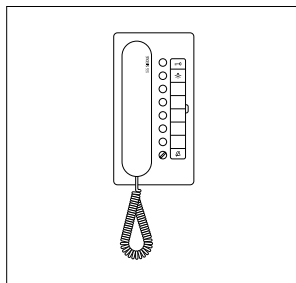

HTC 811-0

Deluxe in-house telephone with the functions:

- Calling, speech, door release and storey call
- Door release and light button
- Rotary controller for ringtone volume with integrated muting
- 6 buttons for switching and control functions, of which two with switchover facility as potential-free buttons
- Internal speech communication with GC 612-...
- 2 LEDs under the buttons to display switching statuses
- Door call as 3-tone chime, storey call as 2-tone call
- Call volume max. 83 dB A

Ambient temperature:

+5 °C to +40 °C

Dimensions (mm) W x H x D:

106 x 201 x 46

Accessories

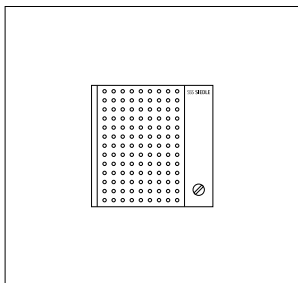

NS 711-01

Secondary signal unit in a low-profile surface-mounting design with loudspeaker, externally adjustable volume control and electronic call generator.

Can be connected to HTS/HTC 811-... Call tones: Door call, 3-tone call signal (without G connection) or chime (with terminal G), storey call, 2-tone call signal. Call volume up to max. 86 dB(A)
Protection system: IP 20
Dimensions (mm) W x H x D:
107 x 107 x 25

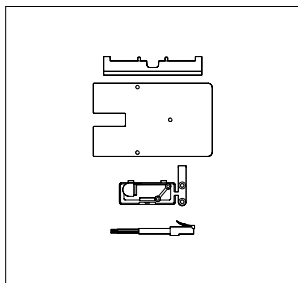

ZTS 800-01

Table-top accessory for telephones BTS/BFC 850-... and HTS 811-... for conversion from a wall to a table-top unit. Slip-proof console with 2 rubber feet but without UAE 8(8) junction box.

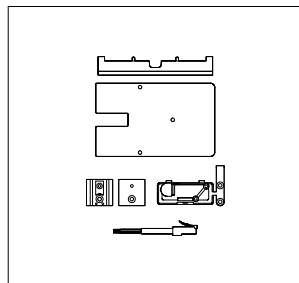

ZTC 800-0

Table-top accessory for the telephone BTC 850-... and HTC 811-... for conversion from a wall to a table-top unit. Slip-proof console with 2 rubber feet but without UAE 8/8(8) junction box.

5 Installation

General information

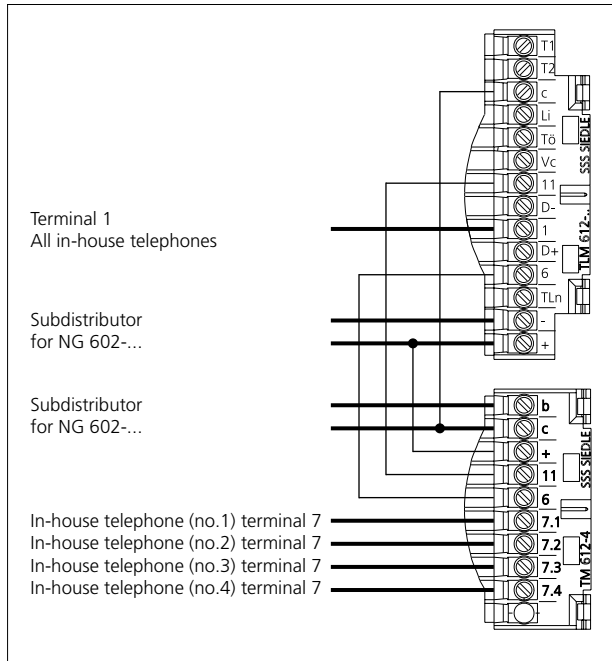

Door station installation

The door loudspeaker module (TLM 612-... and call button module TM 612-...) are each inserted in the relevant terminal block. The circuit diagram illustrates the two terminal blocks of the TLM 612-... and TM 612-...

When **switching several doors in parallel** the terminal TLn must be connected between the door stations to allow synchronization between the door loudspeakers. The jumper of terminal + between the door loudspeaker and call button module must only be inserted at one door station when switching several doors in parallel.

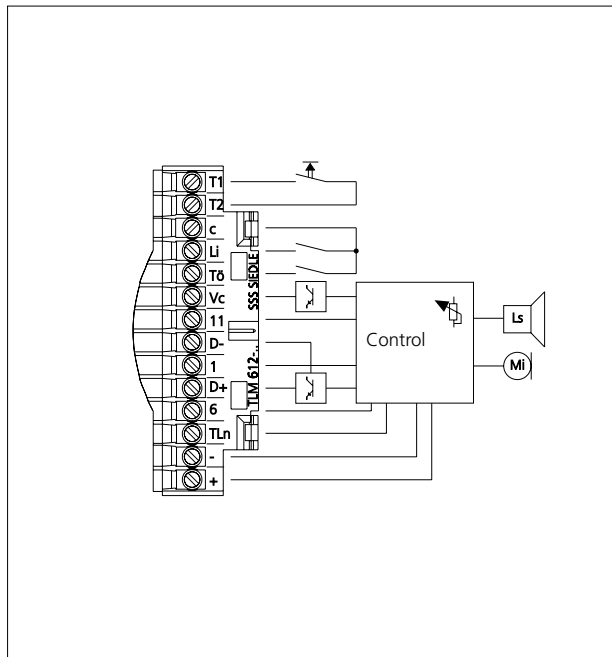

Block diagram of door loudspeaker module TLM 612-...

Terminals of the door loudspeaker module TLM 612-...

- Potential-free light button T1/T2
- Door release contact c/Dr
- Light contact from telephone c/Li
- Vc actuation for video
- Terminal 6 call voltage
- Terminal 11 call current recognition
- D+/D- actuation for SFC 602-.../CT0 602-...
- 1 reference terminal for 1+n
- TLn for synchronization of several door stations
- +/- supply voltage 24 V DC

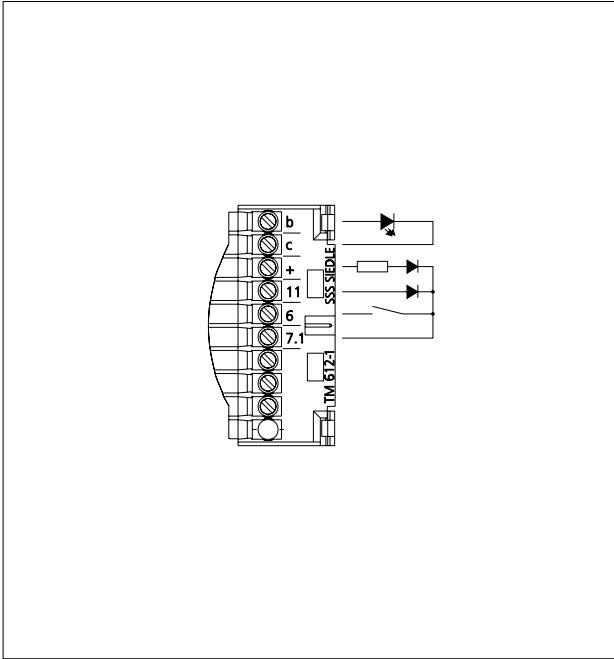

Block diagram of the call button module TM 612-1

- In the idle status, the in-house telephone is supplied with power via the terminal +.
- Potential-free call contact between terminal 6 and 7.1
- The audio privacy device in the door loudspeaker is actuated and communication takes place via terminal 11.

5 Installation

Siedle Vario with IQ HTS

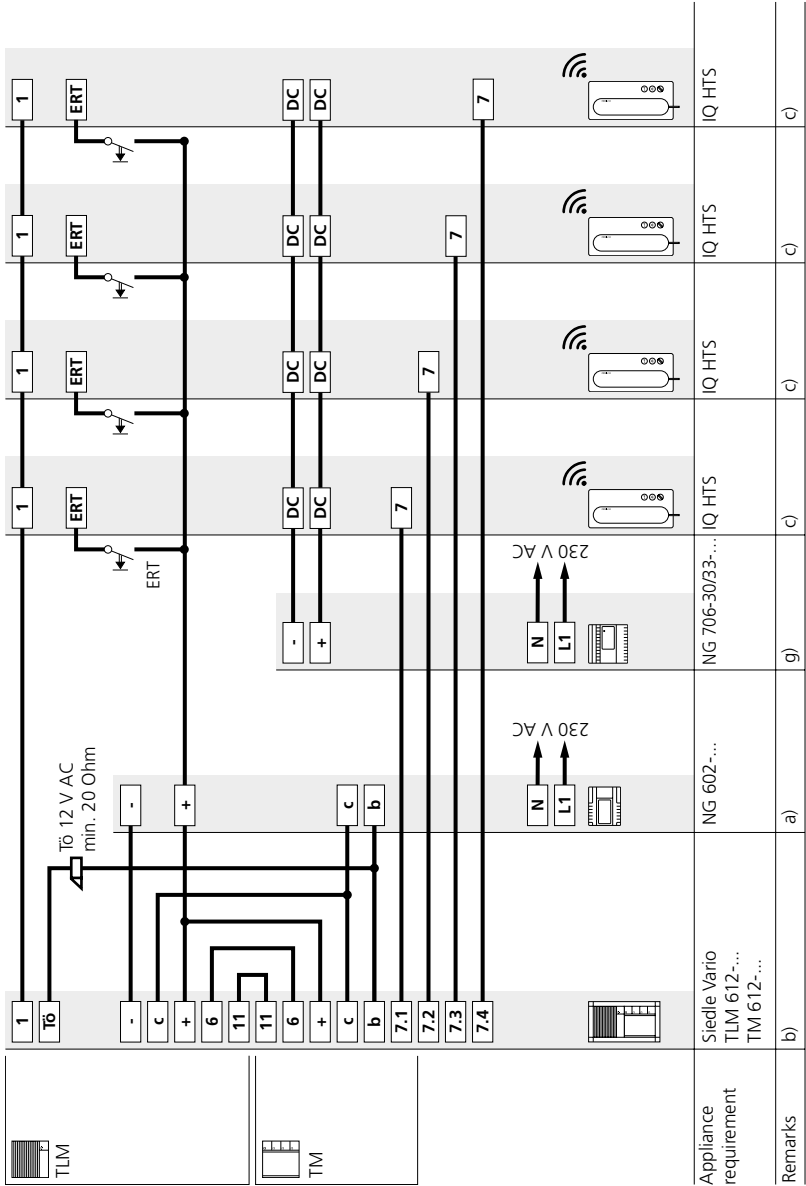

Siedle Vario with IQ HTS

Functional

Call, speech, door release and light on the IQ HTS indoor station and on a smartphone with the Siedle app. Illuminated light button on the door station with a potential-free switching contact.

Connection of a storey call button (ERT) for the call from an apartment door.

Different ringtones for a call from the front door, apartment door or internal call.

Call tones for IQ HTS

A 3-tone call sounds for a door call, a 2-tone call sounds for a storey call

Additional in-house telephones or door stations can be connected. Additional door stations are connected in parallel. If the door release is to be connected in a tamper-proof manner, the CTÖ 602-... controller door release must be used. Additional wires are needed for this.

Supplementary functions

- **Internal speech communication** between the in-house telephones HTC 811-... and group controller GC 612-... is possible.
- **Switching and control functions** are possible with the switching/remote controller SFC 602-...
- A **secondary signal unit** NS 711-... is possible in parallel with an in-house telephone HTS/HTC 811-...
- A **parallel door call** to a maximum of 2 HTS/HTC 811-... units or NSC 602-.../NS 711-... is possible simultaneously. Using the group controller GC 612-... a parallel call is possible to up to 6 in-house telephones.

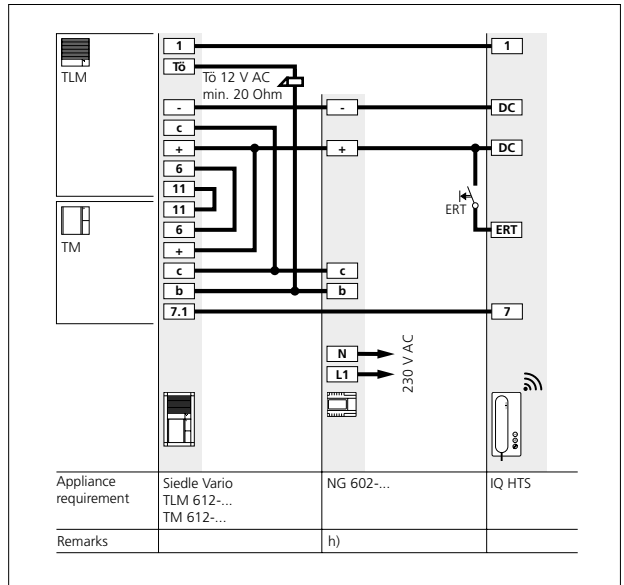

Remarks

- a)** Line rectifier NG 602-... can supply 1 door release and a maximum of 50 call button modules with LED lighting TM 612-1, -2, -3, and -4. With more than 50 illuminated call button modules, an additional TR 603-... is required.
- Door release contact load in the door loudspeaker max. 24 V, 2 A
 - Light contact load in the door loudspeaker max. 24 V, 2 A
- b)** Door release 12 V AC, use at least 20 Ohm (e.g. TÖ 615-...).
- LED lighting per call button module 20 mA
- c)** Conductor length from the in-house telephone to the storey call button ERT max. 50 m/164 ft.

- g)** One NG 706-30/33-... supplies a maximum of 8 IQ HTS. Alternatively, an NG 602-... can be used, this supplies a maximum of two IQ HTS. For more information, see page 57
- h)** One NG 602-... supplies a maximum of one door station, the IQ HTS and optionally one HTS 811-...

5 Installation

Siedle Vario

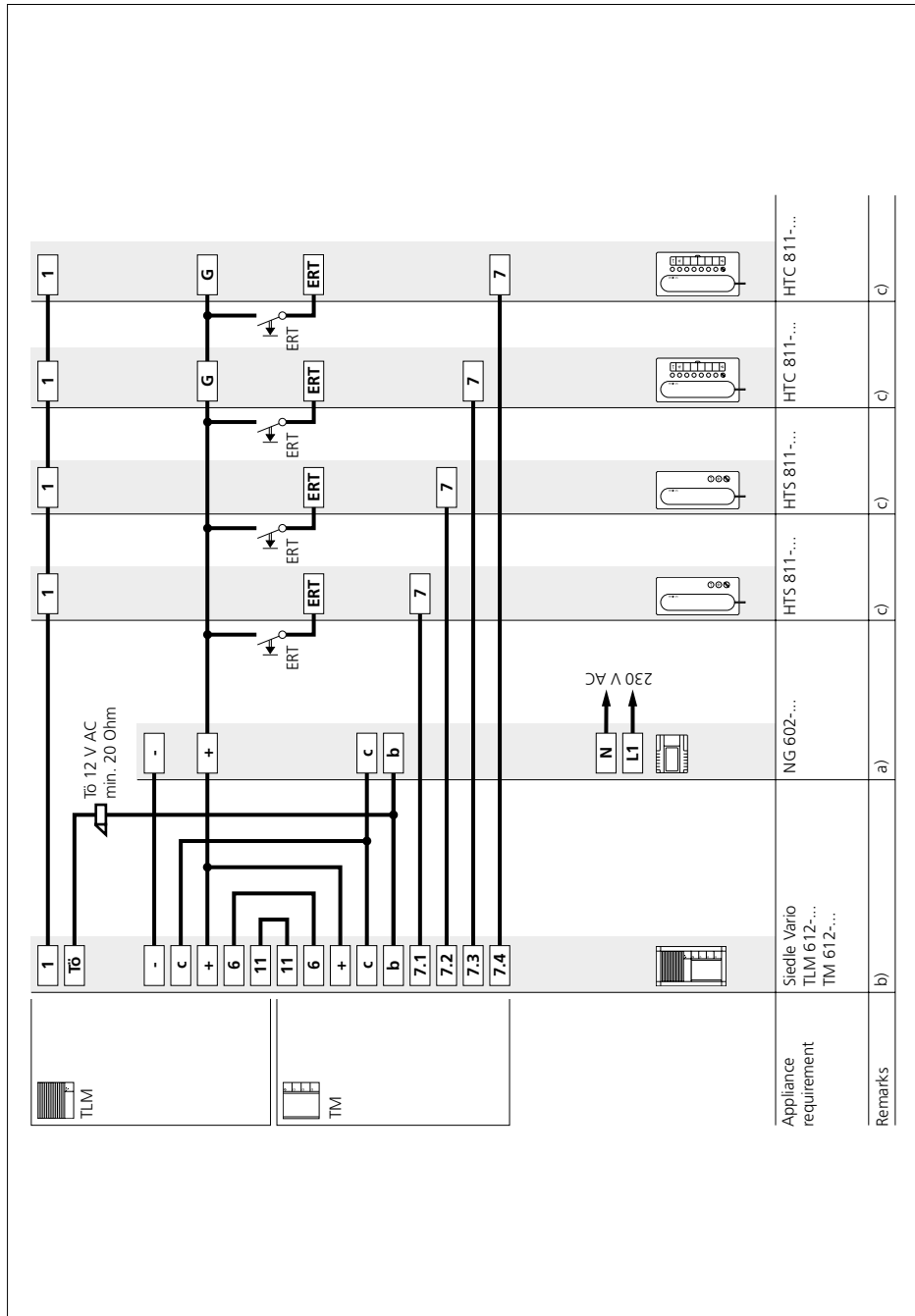

Siedle Vario

Functional

Calling and speech between the door station and connected in-house telephones HTS/HTC 811-... An existing call cannot be listened in to from other in-house telephones. Internal speech communication between the HTC 811-..., which is connected to the GC 612-... Dialling the user with the call buttons on the telephones. The assignment sequence corresponds to the sequence of call buttons. Door release button for the door release function, light button for the light switching function. Illuminated light button at the door station with potential-free switching contact. Connection of a storey call button (ERT) for calling from an apartment door. Different ringtones for calls from the front door, apartment door and for internal calls.

Call tones with HTS 811-...

A call from the door produces a 3-tone call, from the storey door a 2-tone call.

Call tones with HTC 811-...

On a door call, a 3-tone chime sounds, without connection of terminal G a 3-tone call. A storey call produces a 2-tone call, an internal call a 3-tone call.

Connection of additional in-house telephones or door stations possible without switchover device. To ensure tamper-proof connection of the door release, the door release controller CTÖ 602-... has to be used. Additional cores are required for this.

Supplementary functions

• Internal speech communication

between the in-house telephones HTC 811-... and group controller GC 612-... is possible.

• Switching and control functions

are possible with the switching/remote controller SFC 602-...

• A secondary signal unit

NS 711-... is possible in parallel with an in-house telephone HTS/HTC 811-...

• A **parallel door call** to a maximum of 2 HTS/HTC 811-... units or NSC 602-.../NS 711-... is possible simultaneously.

Using the group controller GC 612-... a parallel call is possible to up to 6 in-house telephones.

Remarks

- a)** Line rectifier NG 602-... can supply 1 door release and a maximum of 50 call button modules with LED lighting TM 612-1, -2, -3, and -4. With more than 50 illuminated call button modules, an additional TR 603-... is required.
- Door release contact load in the door loudspeaker max. 24 V, 2 A
 - Light contact load in the door loudspeaker max. 24 V, 2 A
- b)** Door release 12 V AC, use at least 20 Ohm (e.g. TÖ 615-...).
- LED lighting per call button module 20 mA
- c)** Conductor length from the in-house telephone to the storey call button ERT max. 50 m/164 ft.

5 Installation

Siedle custom-fit door loudspeaker

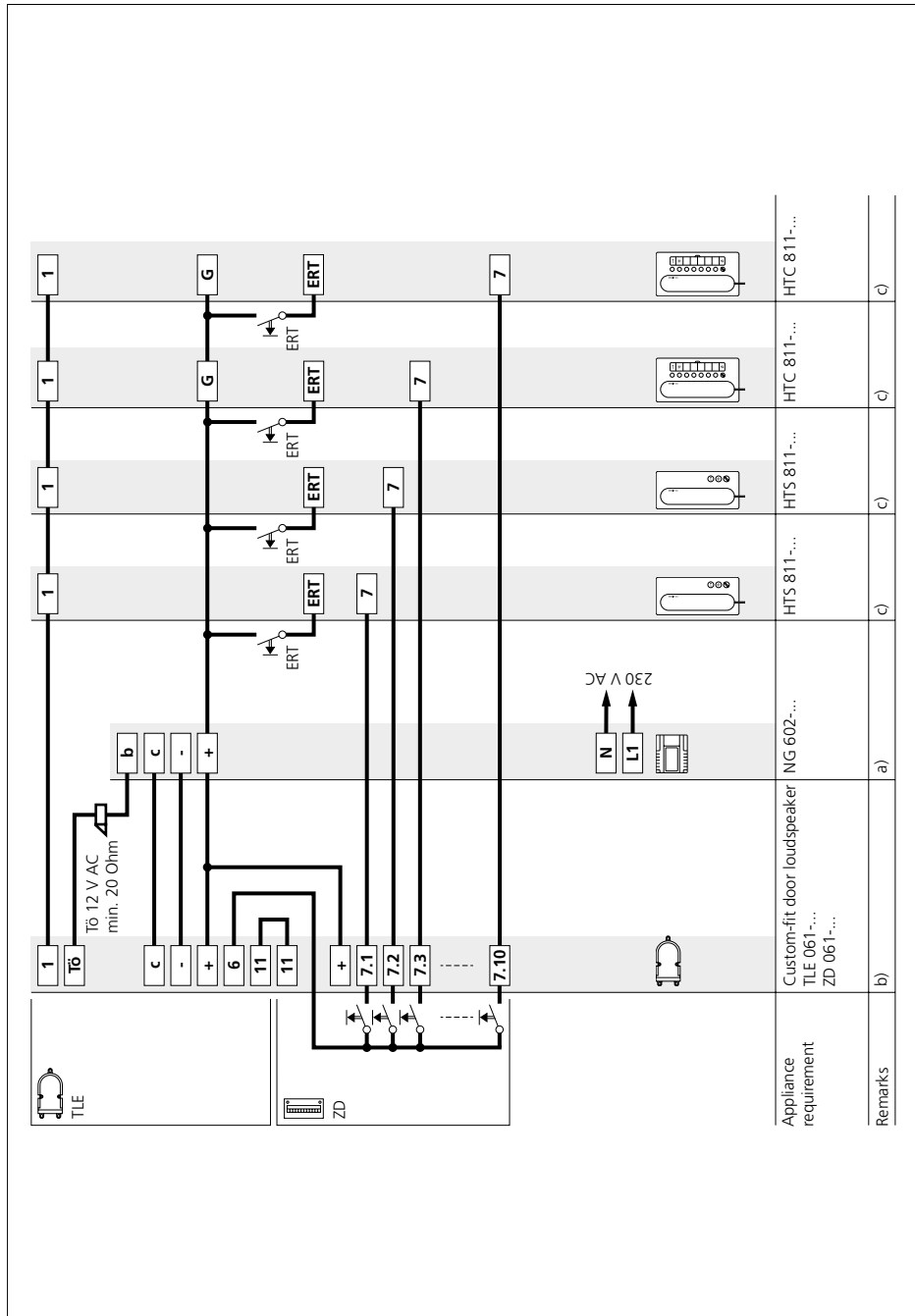

Siedle custom-fit door loud-speaker

Functional

Calling and speech between the door station and connected in-house telephones HTS/HTC 811-... An existing call cannot be listened in to from other in-house telephones.

Internal speech communication between the HTC 811-..., which is connected to the GC 612-... Dialling the user with the call buttons on the telephones. The assignment sequence corresponds to the sequence of call buttons.

Door release button for the door release function, light button for the light switching function. Illuminated light button at the door station with potential-free switching contact. Connection of a storey call button (ERT) for calling from an apartment door.

Different ringtones for calls from the front door, apartment door and for internal calls.

Call tones with HTS 811-...

A call from the door produces a 3-tone call, from the storey door a 2-tone call.

Call tones with HTC 811-...

On a door call, a 3-tone chime sounds, without connection of terminal G a 3-tone call. A storey call produces a 2-tone call, an internal call a 3-tone call.

Connection of additional in-house telephones or door stations possible without switchover device. To ensure tamper-proof connection of the door release, the door release controller CTÖ 602-... has to be used. Additional cores are required for this.

Supplementary functions

- **Internal speech communication** between the in-house telephones HTC 811-... and group controller GC 612-... is possible.

- **Switching and control functions** are possible with the switching/remote controller SFC 602-...

- A **secondary signal unit** NS 711-... is possible in parallel with an in-house telephone HTS/HTC 811-...

- A **parallel door call** to a maximum of 2 HTS/HTC 811-... units or NSC 602-.../NS 711-... is possible simultaneously.

Using the group controller GC 612-... a parallel call is possible to up to 6 in-house telephones.

Remarks

a) The NG 602-... is also able to supply the customer's own call buttons. A voltage of 12 V AC max. 1 A is available for the lighting if a door release with an impedance of at least 20 Ohm is used. With a higher current consumption, an additional transformer must be used.

- Door release contact load in the door loudspeaker max. 24 V, 2 A

- Light contact load in the door loudspeaker max. 24 V, 2 A

b) Door release 12 V AC, use at least 20 Ohm (e.g. TÖ 615-...).

c) Conductor length from the in-house telephone to the storey call button ERT max. 50 m/164 ft.

5 Installation

Siedle Classic

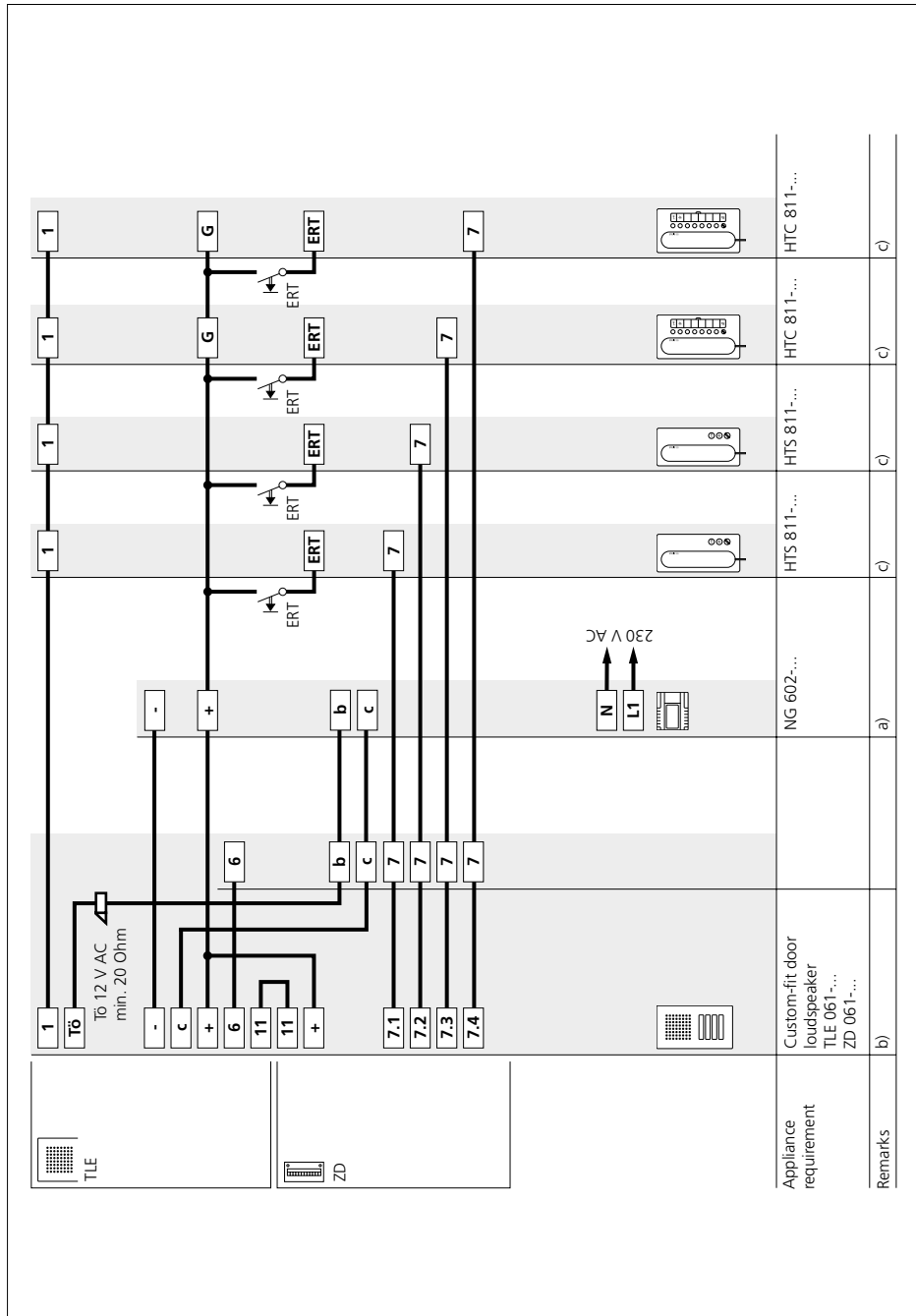

Siedle Classic

Functional

Calling and speech between the door station and connected in-house telephones HTS/HTC 811-... An existing call cannot be listened in to from other in-house telephones. Internal speech communication between the HTC 811-..., which is connected to the GC 612-... Dialling the user with the call buttons on the telephones. The assignment sequence corresponds to the sequence of call buttons. Door release button for the door release function, light button for the light switching function. Illuminated light button at the door station with potential-free switching contact. Connection of a storey call button (ERT) for calling from an apartment door. Different ringtones for calls from the front door, apartment door and for internal calls.

Call tones with HTS 811-...

A call from the door produces a 3-tone call, from the storey door a 2-tone call.

Call tones with HTC 811-...

On a door call, a 3-tone chime sounds, without connection of terminal G a 3-tone call. A storey call produces a 2-tone call, an internal call a 3-tone call.

Connection of additional in-house telephones or door stations possible without switchover device. To ensure tamper-proof connection of the door release, the door release controller CTÖ 602-... has to be used. Additional cores are required for this.

Supplementary functions

- **Internal speech communication** between the in-house telephones HTC 811-... and group controller GC 612-... is possible.
- **Switching and control functions** are possible with the switching/remote controller SFC 602-...
- A **secondary signal unit** NS 711-... is possible in parallel with an in-house telephone HTS/HTC 811-...
- A **parallel door call** to a maximum of 2 HTS/HTC 811-... units or NSC 602-.../NS 711-... is possible simultaneously. Using the group controller GC 612-... a parallel call is possible to up to 6 in-house telephones.

Remarks

- a)** Line rectifier NG 602-... can supply 1 door release and lighting for appr. 200 call buttons. With more than 200 illuminated call button modules, an additional TR 603-... is required.
- Door release contact load in the door loudspeaker max. 24 V, 2 A
- Light contact load in the door loudspeaker max. 24 V, 2 A
- b)** Door release 12 V AC, use at least 20 Ohm (e.g. TÖ 615-...).
- LED lighting per call button 5 mA
- c)** Conductor length from the in-house telephone to the storey call button ERT max. 50 m/164 ft.

5 Installation

Siedle Steel

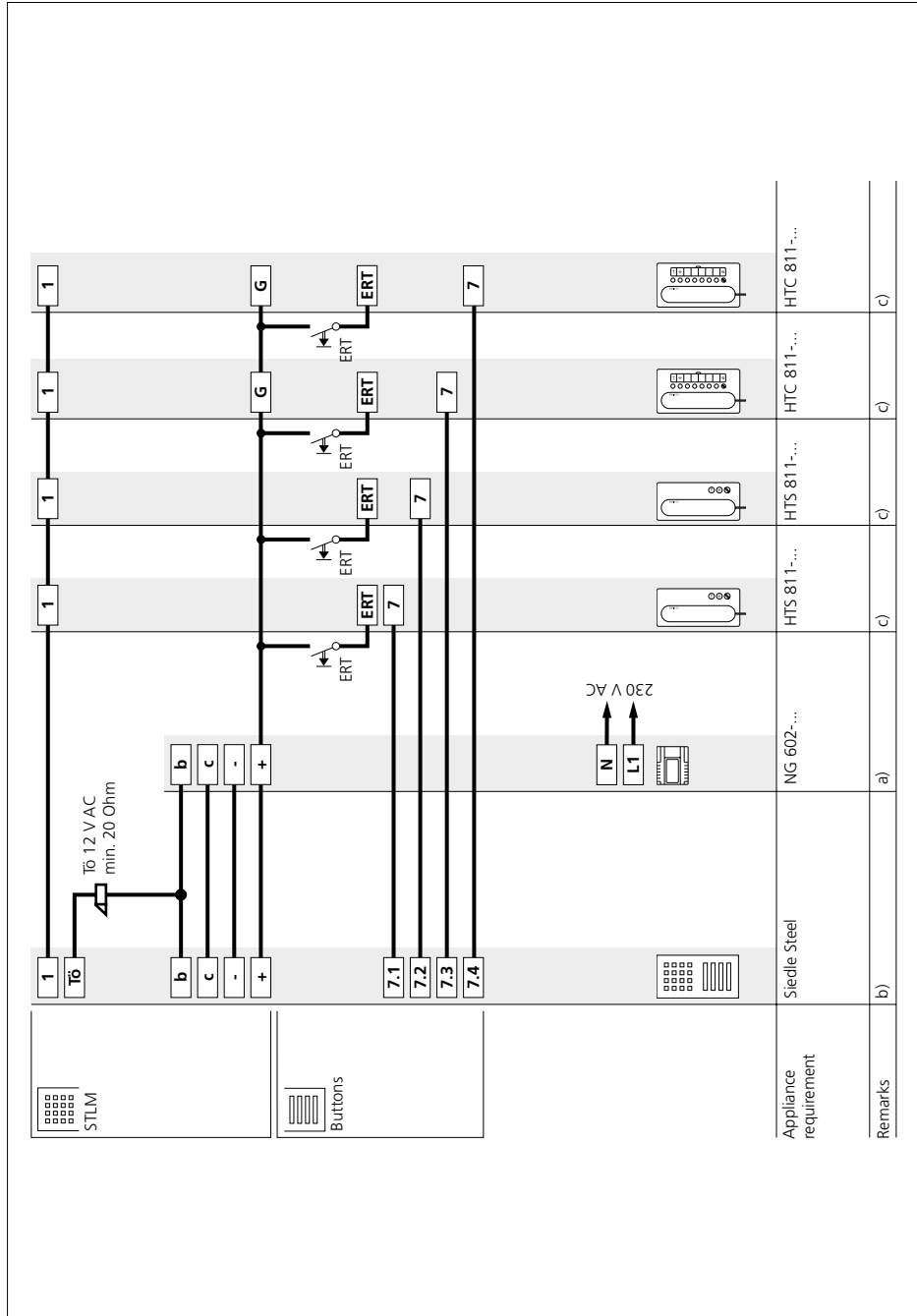

Appliance requirement	Siedle Steel	NG 602-...	HTS 811-...	HTS 811-...	HTC 811-...	HTC 811-...
Remarks	b)	a)	c)	c)	c)	c)

Siedle Steel

Functional

Calling and speech between the door station and connected in-house telephones HTS/HTC 811-... An existing call cannot be listened in to from other in-house telephones. Internal speech communication between the HTC 811-..., which is connected to the GC 612-... Dialling the user with the call buttons on the telephones. The assignment sequence corresponds to the sequence of call buttons. Door release button for the door release function, light button for the light switching function. Illuminated light button at the door station with potential-free switching contact. Connection of a storey call button (ERT) for calling from an apartment door. Different ringtones for calls from the front door, apartment door and for internal calls.

Call tones with HTS 811-...

A call from the door produces a 3-tone call, from the storey door a 2-tone call.

Call tones with HTC 811-...

On a door call, a 3-tone chime sounds, without connection of terminal G a 3-tone call. A storey call produces a 2-tone call, an internal call a 3-tone call.

Connection of additional in-house telephones or door stations possible without switchover device. To ensure tamper-proof connection of the door release, the door release controller CTÖ 602-... has to be used. Additional cores are required for this.

Supplementary functions

• Internal speech communication

between the in-house telephones HTC 811-... and group controller GC 612-... is possible.

• Switching and control functions

are possible with the switching/remote controller SFC 602-...

• A secondary signal unit

NS 711-... is possible in parallel with an in-house telephone HTS/HTC 811-...

• A **parallel door call** to a maximum of 2 HTS/HTC 811-... units or NSC 602-.../NS 711-... is possible simultaneously.

Using the group controller GC 612-... a parallel call is possible to up to 6 in-house telephones.

Remarks

a) Line rectifier NG 602-... can supply 1 door release and lighting for appr. 330 call buttons. With more than 330 illuminated call button modules, an additional TR 603-... is required.

• Door release contact load in the door loudspeaker max. 24 V, 2 A

• Light contact load in the door loudspeaker max. 24 V, 2 A

b) Door release 12 V AC, use at least 20 Ohm (e.g. TÖ 615-...).

• LED lighting per call button 3 mA
c) Conductor length from the in-house telephone to the storey call button ERT max. 50 m/164 ft.

The Siedle-Steel door station STL ... is fully wired in the factory.

If there are several door stations integrated in the system, with the **2nd** to the **xth** STL ... the door intercom system must be removed in each case and the jumpers located behind it from "+ and 7.1" to "+ and 7.5" and also if applicable "+ and 7 ..." must be taken out. For instructions on how to remove the jumpers, refer to the Siedle Steel product information.

In-house telephones which are connected **to only one** STL -... **must always** be connected to 7.1 to 7.5. If the in-house telephone is connected e.g. at terminal 7.4, at this STL ... the jumpers "+ and 7.1" to "+ and 7.3", "+ and 7.5" and where available also "+ and 7..." must be taken out.

If there are more than 5 call buttons at the STL ..., these are routed to the add-on call button extension circuit board.

5 Installation

DoorCom Analog DCA 612-...

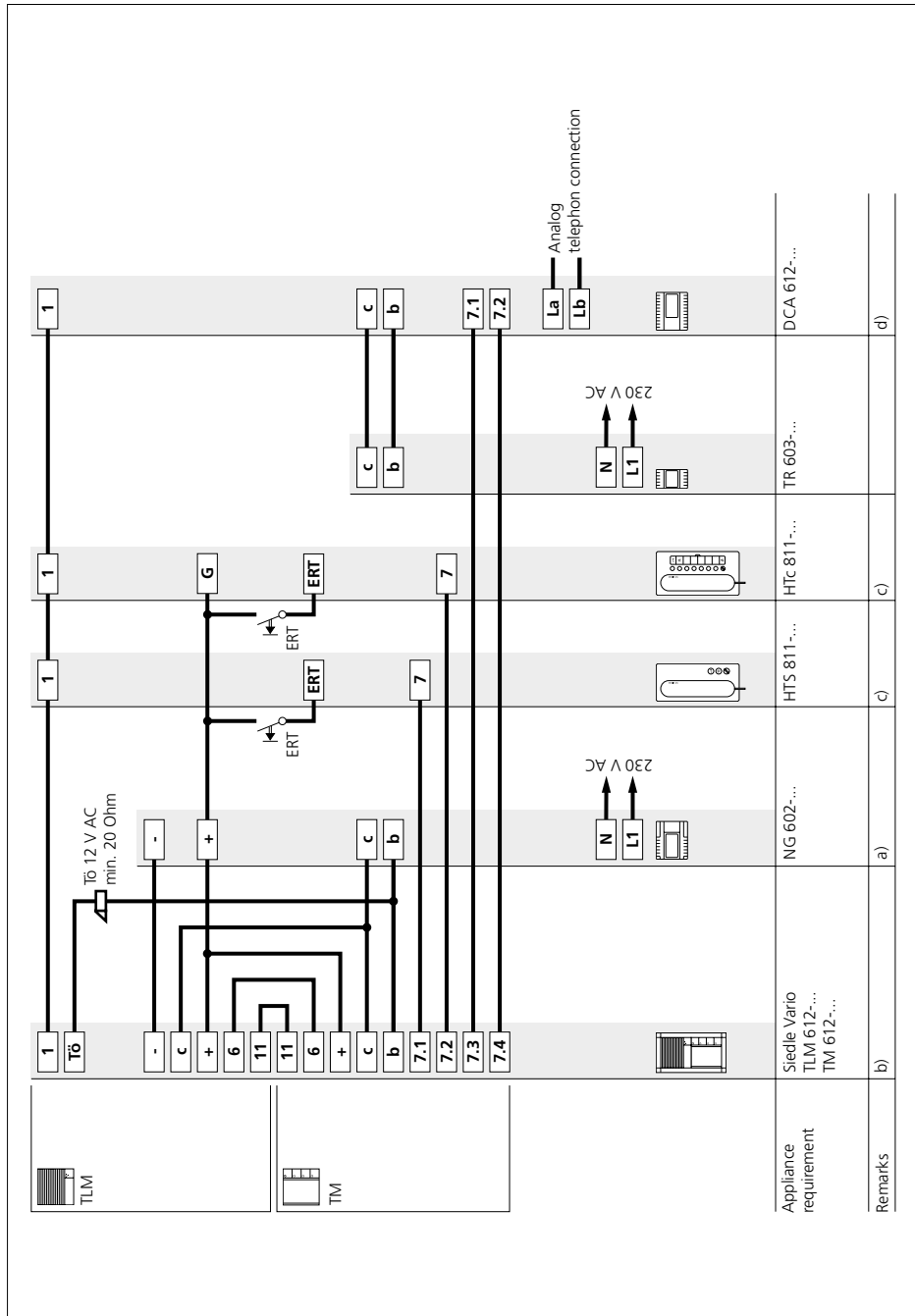

DoorCom Analog DCA 612-...

Functional

Calling and speech between the door station and connected in-house telephones HTS/HTC 811-...

An existing call cannot be listened in to from other in-house telephones.

Door release button for the door release function, light button for the light switching function. Illuminated light button at the door station with potential-free switching contact.

Connection of a storey call button (ERT) for calling from an apartment door.

Different ringtones for calls from the front door, apartment door and for internal calls.

Up to 3 call buttons can be connected at the DoorCom DCA 612-... and can call different users of a telephone system. Users are dialled using the dual tone multifrequency dialling method DTMF.

Call tones with HTS 811-...

A call from the door produces a 3-tone call, from the storey door a 2-tone call.

Call tones with HTC 811-...

On a door call, a 3-tone chime sounds, without connection of terminal G a 3-tone call. On a storey call, a 2-tone call sounds.

Connection of additional in-house telephones or door stations is possible without switchover device. To ensure tamper-proof connection of the door release, the door release controller CTÖ 602-... has to be used. Additional cores are required for this.

Supplementary functions

- **Internal speech communication** between the in-house telephones HTC 811-... and group controller GC 612-... is possible.

- **Switching and control functions** are possible with the switching/remote controller SFC 602-...

- A **secondary signal unit** NS 711-... is possible in parallel with an in-house telephone HTS/HTC 811-...

- A **parallel door call** to a maximum of 2 HTS/HTC 811-... units or NSC 602-.../NS 711-... is possible simultaneously.

Using the group controller GC 612-... a parallel call is possible to up to 6 in-house telephones.

Remarks

- a)** Line rectifier NG 602-... can supply 1 door release and a maximum of 50 call button modules with LED lighting TM 612-1, -2, -3, and -4. With more than 50 illuminated call button modules, an additional TR 603-... is required.
- Door release contact load in the door loudspeaker max. 24 V, 2 A
- Light contact load in the door loudspeaker max. 24 V, 2 A
- b)** Door release 12 V AC, use at least 20 Ohm (e.g. TÖ 615-...).
- LED lighting per call button 20 mA
- c)** Conductor length from the in-house telephone to the storey call button ERT max. 50 m/164 ft.
- d)** The maximum distance of the DCA 612-... to the NG 602-... is 20 m. For greater distances, an additional transformer is required for the DCA 612-... If several DCA 612-... units are used within a system, each DCA 612-... must be supplied by its own transformer TR 603-...
- At call button module TM 612-... there must not be a connection from the "b" terminal to another terminal of the door station, except if several TM 612-... units are used in a system. Only then may the "b" terminals be connected to each other.

5 Installation

Siedle Vario 2 door stations

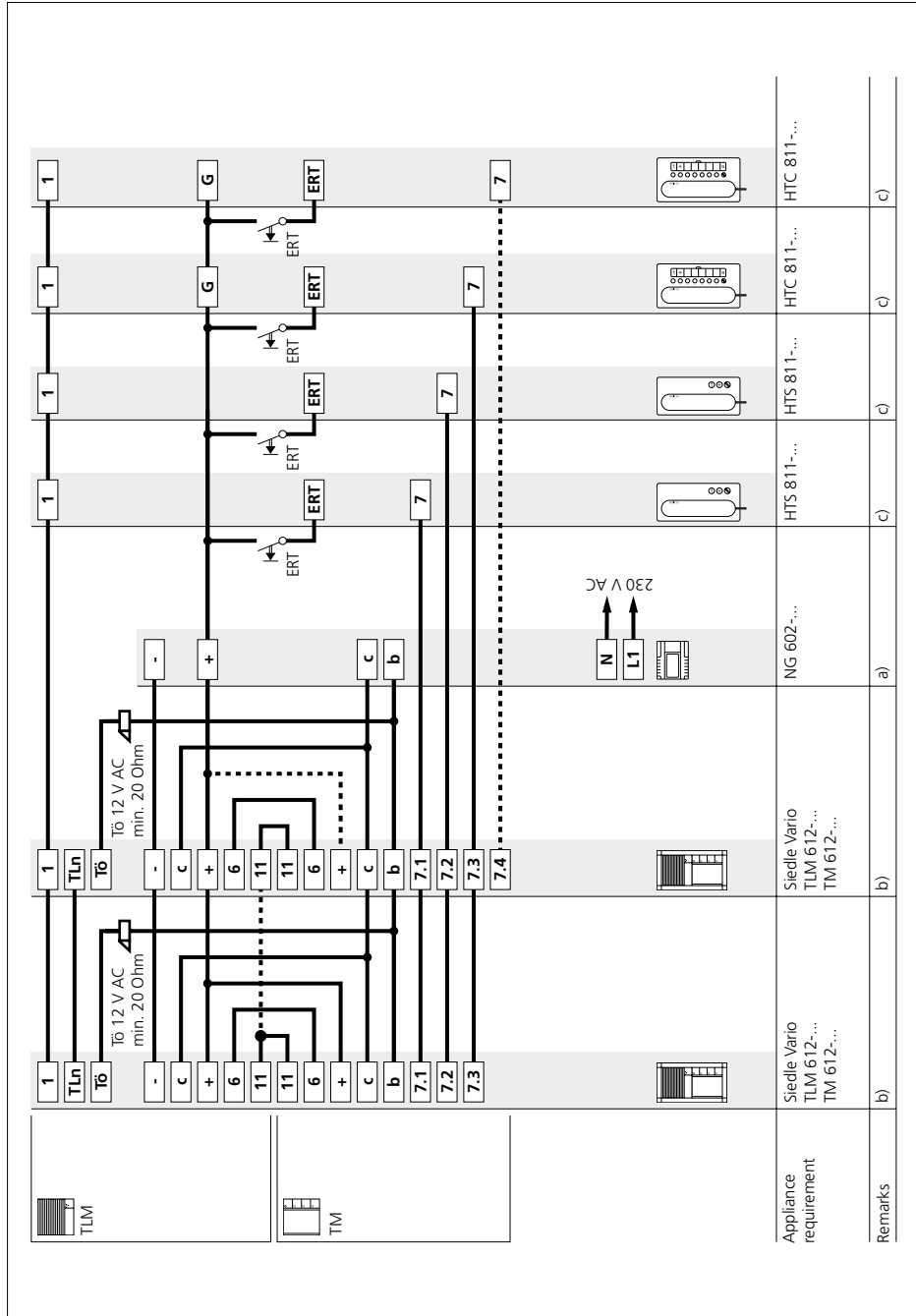

Siedle Vario 2 door stations

Functional

Calling and speech between the door station and connected in-house telephones HTS/HTC 811-... An existing call cannot be listened in to from other in-house telephones. Internal speech communication between the HTC 811-..., which is connected to the GC 612-... Dialling the user with the call buttons on the telephones. The assignment sequence corresponds to the sequence of call buttons. Door release button for the door release function, light button for the light switching function. Illuminated light button at the door station with potential-free switching contact. Connection of a storey call button (ERT) for calling from an apartment door. Different ringtones for calls from the front door, apartment door and for internal calls.

Call tones with HTS 811-...

A call from the door produces a 3-tone call, from the storey door a 2-tone call.

Call tones with HTC 811-...

On a door call, a 3-tone chime sounds, without connection of terminal G a 3-tone call. A storey call produces a 2-tone call, an internal call a 3-tone call.

Connection of additional in-house telephones or door stations possible without switchover device. To ensure tamper-proof connection of the door release, the door release controller CTÖ 602-... has to be used. Additional cores are required for this.

Supplementary functions

- **Internal speech communication** between the in-house telephones HTC 811-... and group controller GC 612-... is possible.
- **Switching and control functions** are possible with the switching/remote controller SFC 602-...
- A **secondary signal unit** NS 711-... is possible in parallel with an in-house telephone HTS/HTC 811-...
- A **parallel door call** to a maximum of 2 HTS/HTC 811-... units or NSC 602-.../NS 711-... is possible simultaneously. Using the group controller GC 612-... a parallel call is possible to up to 6 in-house telephones.

Remarks

- a)** Line rectifier NG 602-... can supply 1 door release and a maximum of 50 call button modules with LED lighting TM 612-1, -2, -3, and -4. With more than 50 illuminated call button modules, an additional TR 603-... is required.
- Door release contact load in the door loudspeaker max. 24 V, 2 A
- Light contact load in the door loudspeaker max. 24 V, 2 A
- b)** Door release 12 V AC, use at least 20 Ohm (e.g. TÖ 615-...).
- LED lighting per call button 20 mA
- c)** Conductor length from the in-house telephone to the storey call button ERT max. 50 m/164 ft.

5 Installation

Siedle custom-fit door loudspeaker with 2 door stations

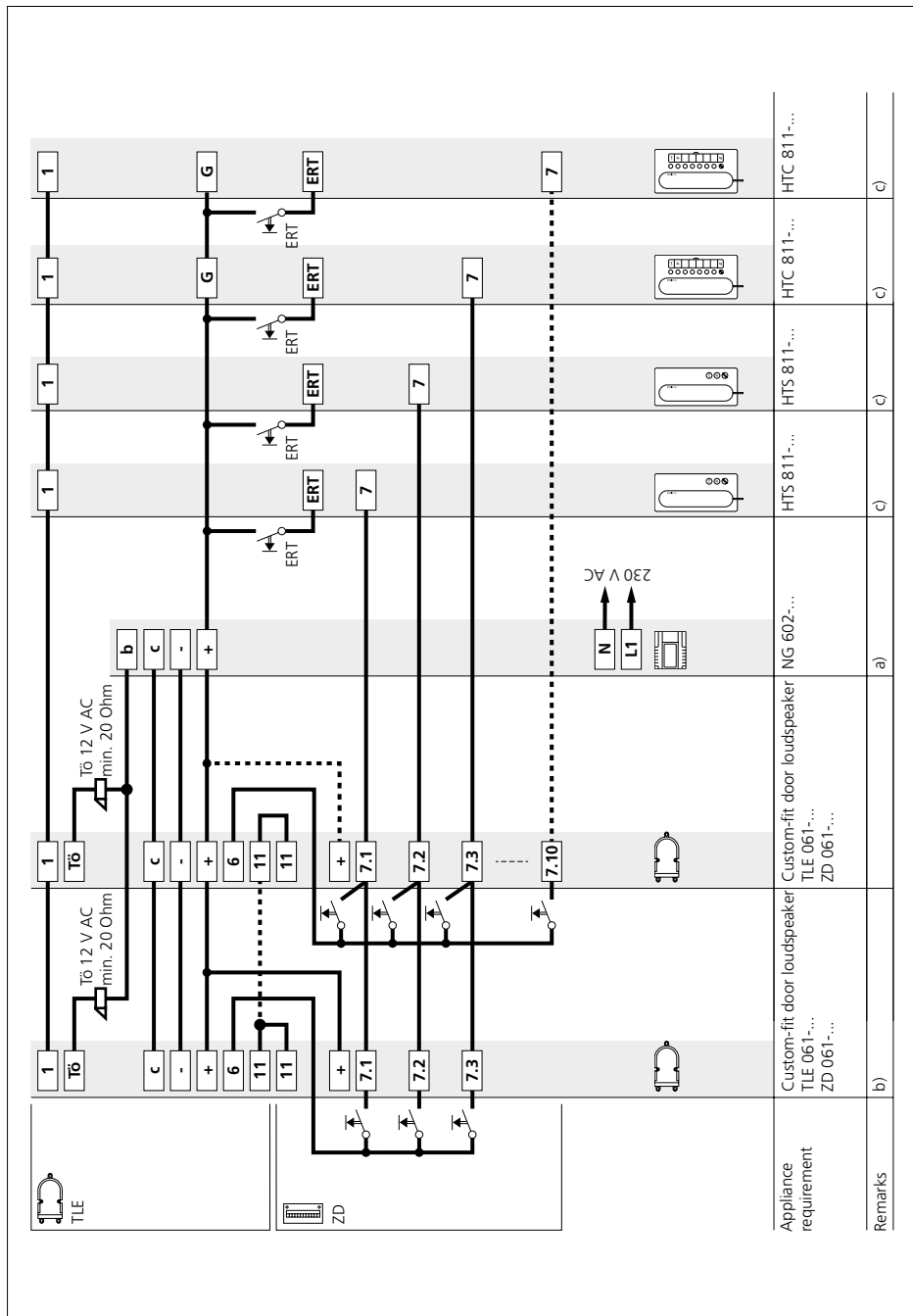

Siedle custom-fit door loud-speaker with 2 door stations

Functional

Calling and speech between the door station and connected in-house telephones HTS/HTC 811-... An existing call cannot be listened in to from other in-house telephones.

Internal speech communication between the HTC 811-..., which is connected to the GC 612-... Dialling the user with the call buttons on the telephones. The assignment sequence corresponds to the sequence of call buttons.

Door release button for the door release function, light button for the light switching function. Illuminated light button at the door station with potential-free switching contact. Connection of a storey call button (ERT) for calling from an apartment door.

Different ringtones for calls from the front door, apartment door and for internal calls.

Call tones with HTS 811-...

A call from the door produces a 3-tone call, from the storey door a 2-tone call.

Call tones with HTC 811-...

On a door call, a 3-tone chime sounds, without connection of terminal G a 3-tone call. A storey call produces a 2-tone call, an internal call a 3-tone call.

Connection of additional in-house telephones or door stations possible without switchover device. To ensure tamper-proof connection of the door release, the door release controller CTÖ 602-... has to be used. Additional cores are required for this.

Supplementary functions

- **Internal speech communication** between the in-house telephones HTC 811-... and group controller GC 612-... is possible.

- **Switching and control functions** are possible with the switching/remote controller SFC 602-...

- A **secondary signal unit** NS 711-... is possible in parallel with an in-house telephone HTS/HTC 811-...

- A **parallel door call** to a maximum of 2 HTS/HTC 811-... units or NSC 602-.../NS 711-... is possible simultaneously.

Using the group controller GC 612-... a parallel call is possible to up to 6 in-house telephones.

Remarks

a) The NG 602-... is also able to supply the customer's own call buttons. A voltage of 12 V AC max. 1 A is available for the lighting if a door release with an impedance of at least 20 Ohm is used. With a higher current consumption, an additional transformer must be used.

- Door release contact load in the door loudspeaker max. 24 V, 2 A

- Light contact load in the door loudspeaker max. 24 V, 2 A

b) Door release 12 V AC, use at least 20 Ohm (e.g. TÖ 615-...).

c) Conductor length from the in-house telephone to the storey call button ERT max. 50 m/164 ft.

5 Installation

Siedle Vario 3 door stations

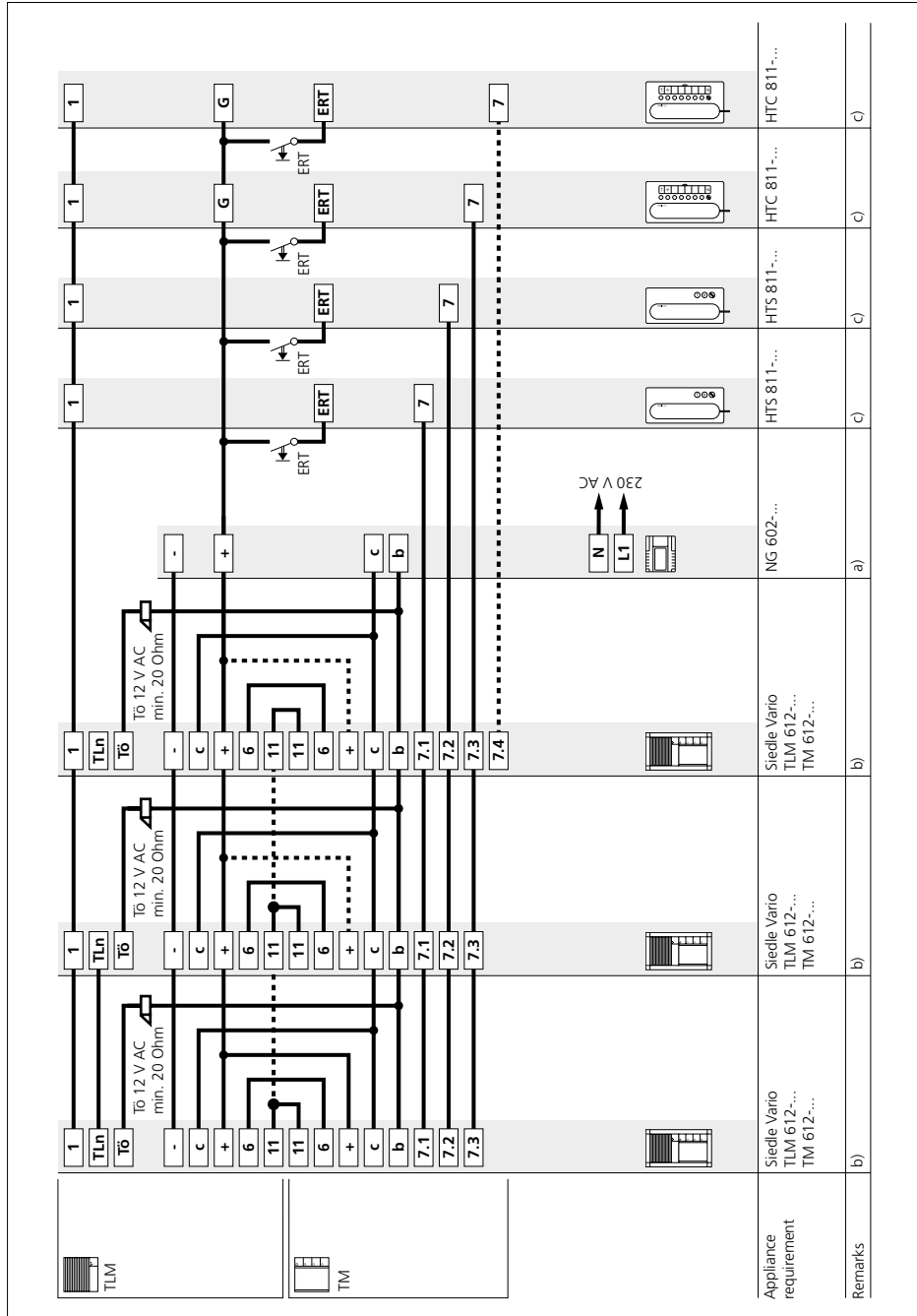

Siedle Vario 3 door stations

Functional

Calling and speech between the door station and connected in-house telephones HTS/HTC 811-... An existing call cannot be listened in to from other in-house telephones. Internal speech communication between the HTC 811-..., which is connected to the GC 612-... Dialling the user with the call buttons on the telephones. The assignment sequence corresponds to the sequence of call buttons. Door release button for the door release function, light button for the light switching function. Illuminated light button at the door station with potential-free switching contact. Connection of a storey call button (ERT) for calling from an apartment door. Different ringtones for calls from the front door, apartment door and for internal calls.

Call tones with HTS 811-...

A call from the door produces a 3-tone call, from the storey door a 2-tone call.

Call tones with HTC 811-...

On a door call, a 3-tone chime sounds, without connection of terminal G a 3-tone call. A storey call produces a 2-tone call, an internal call a 3-tone call.

Connection of additional in-house telephones or door stations possible without switchover device. To ensure tamper-proof connection of the door release, the door release controller CTÖ 602-... has to be used. Additional cores are required for this.

Supplementary functions

- **Internal speech communication** between the in-house telephones HTC 811-... and group controller GC 612-... is possible.
- **Switching and control functions** are possible with the switching/remote controller SFC 602-...
- A **secondary signal unit** NS 711-... is possible in parallel with an in-house telephone HTS/HTC 811-...
- A **parallel door call** to a maximum of 2 HTS/HTC 811-... units or NSC 602-.../NS 711-... is possible simultaneously. Using the group controller GC 612-... a parallel call is possible to up to 6 in-house telephones.

Remarks

- a)** Line rectifier NG 602-... can supply 1 door release and a maximum of 50 call button modules with LED lighting TM 612-1, -2, -3, and -4. With more than 50 illuminated call button modules, an additional TR 603-... is required.
- Door release contact load in the door loudspeaker max. 24 V, 2 A
- Light contact load in the door loudspeaker max. 24 V, 2 A
- b)** Door release 12 V AC, use at least 20 Ohm (e.g. TÖ 615-...).
- LED lighting per call button 20 mA
- c)** Conductor length from the in-house telephone to the storey call button ERT max. 50 m/164 ft.

5 Installation

Siedle Vario, internal speech communication

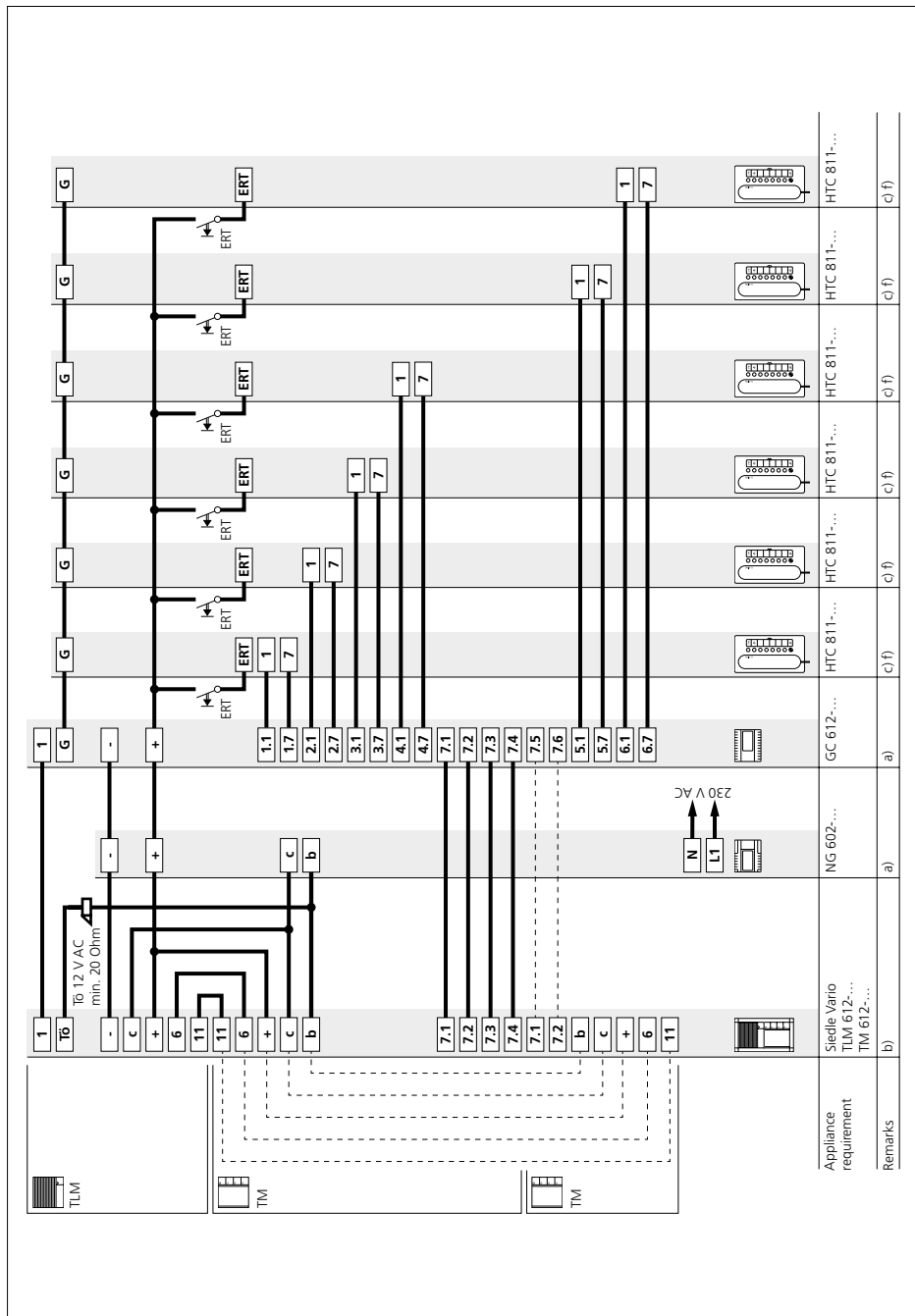

Siedle Vario, internal speech communication

Functional

Calling and speech between the door station and connected in-house telephones HTS/HTC 811-... An existing call cannot be listened in to from other in-house telephones. Door release button for the door release function, light button for the light switching function. Illuminated light button at the door station with potential-free switching contact. Storey door station for the functions calling, speech and door release from one storey door station. Several storey door stations can be connected in parallel. Connection of a storey call button (ERT) for placing calls from an additional door is possible, but not yet indicated in this wiring diagram. Different ringtones for calls from the front door, storey door or for internal calls.

Call tones with HTS 811-...

A call from the door produces a 3-tone call, from the storey door a 2-tone call.

Call tones with HTC 811-...

On a door call, a 3-tone chime sounds, without connection of terminal G a 3-tone call. A storey call produces a 2-tone call, an internal call a 3-tone call.

Connection of additional in-house telephones or door stations possible without switchover device. To ensure tamper-proof connection of the door release, the door release controller CTÖ 602-... has to be used. Additional cores are required for this.

Supplementary functions

• **Switching and control functions** are possible with the switching/remote controller SFC 602-...

• A **secondary signal unit** NS 711-... is possible in parallel with an in-house telephone HTS/HTC 811-...

• A **parallel door call** to a maximum of 2 HTS/HTC 811-... units or NSC 602-.../NS 711-... is possible simultaneously.

Remarks

- a)** Line rectifier NG 602-... can supply 1 door release and a maximum of 50 call button modules with LED lighting TM 612-1, -2, -3, and -4. With more than 50 illuminated call button modules, an additional TR 603-... is required.
- Door release contact load in the door loudspeaker max. 24 V, 2 A
 - Light contact load in the door loudspeaker max. 24 V, 2 A
- b)** Door release 12 V AC, use at least 20 Ohm (e.g. TÖ 615-...).
- LED lighting per call button 20 mA
- c)** Conductor length from the in-house telephone to the storey call button ERT max. 50 m/164 ft.
- f)** In the in-house telephones HTC 811-... DIL switch 5 must be set to OFF.
- For more information, see page 44

5 Installation

Siedle Vario 1 main door station, 1 storey door station

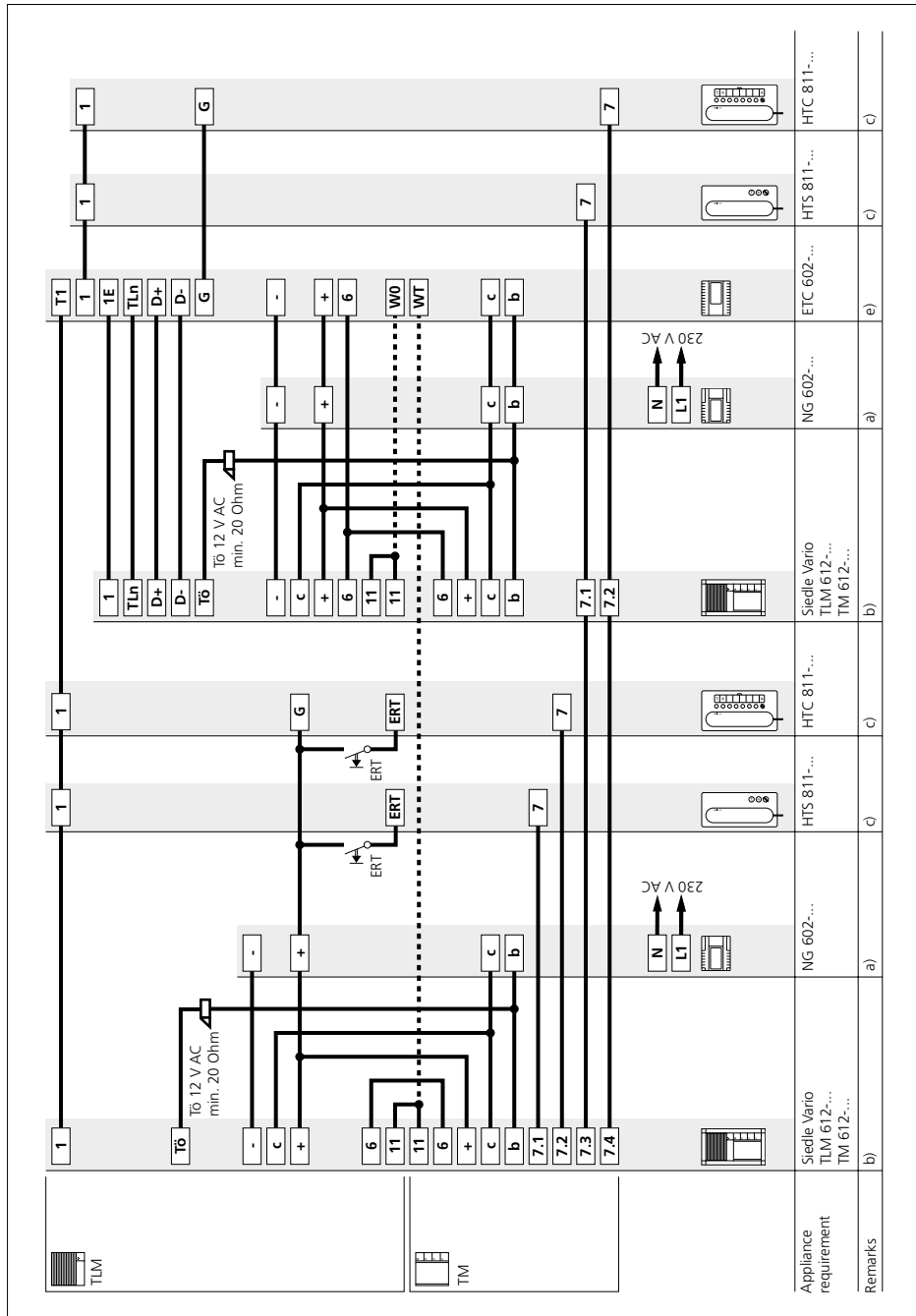

Siedle Vario 1 main door station, 1 storey door station

Functional

Calling and speech between the door station and connected in-house telephones HTS/HTC 811-... An existing call cannot be listened in to from other in-house telephones.

Door release button for the door release function, light button for the light switching function. Illuminated light button at the door station with potential-free switching contact. Storey door station for the functions calling, speech and door release from one storey door station. Several storey door stations can be connected in parallel.

Connection of a storey call button (ERT) for placing calls from an additional door is possible, but not yet indicated in this wiring diagram. Different ringtones for calls from the front door, storey door or for internal calls.

Call tones with HTS 811-...

A call from the door produces a 3-tone call, from the storey door a 2-tone call.

Call tones with HTC 811-...

On a door call, a 3-tone chime sounds, without connection of terminal G a 3-tone call. A storey call produces a 2-tone call, an internal call a 3-tone call.

Connection of additional in-house telephones or door stations possible without switchover device. To ensure tamper-proof connection of the door release, the door release controller CTÖ 602-... has to be used. Additional cores are required for this.

Supplementary functions

- **Internal speech communication** between the in-house telephones HTC 811-... and group controller GC 612-... is possible.

- **Switching and control functions** are possible with the switching/remote controller SFC 602-...

- A **secondary signal unit** NS 711-... is possible in parallel with an in-house telephone HTS/HTC 811-...

- A **parallel door call** to a maximum of 2 HTS/HTC 811-... units or NSC 602-.../NS 711-... is possible simultaneously.

Using the group controller GC 612-... a parallel call is possible to up to 6 in-house telephones.

Remarks

- a)** Line rectifier NG 602-... can supply 1 door release and a maximum of 50 call button modules with LED lighting TM 612-1, -2, -3, and -4. With more than 50 illuminated call button modules, an additional TR 603-... is required.
- Door release contact load in the door loudspeaker max. 24 V, 2 A
- Light contact load in the door loudspeaker max. 24 V, 2 A
- b)** Door release 12 V AC, use at least 20 Ohm (e.g. TÖ 615-...).
- LED lighting per call button 20 mA
- c)** Conductor length from the in-house telephone to the storey call button ERT max. 50 m/164 ft.
- e)** If an in-house telephone is only connected to one storey door station, the dotted connection must be made from terminal 11 at the main door loudspeaker to terminal WT of the storey controller ETC 602-... In addition, the connection is required from terminal W0 ETC 602-... to terminal 11 storey door station.

5 Installation

Siedle Vario 1 main door station, 1 storey door station,
internal speech communication

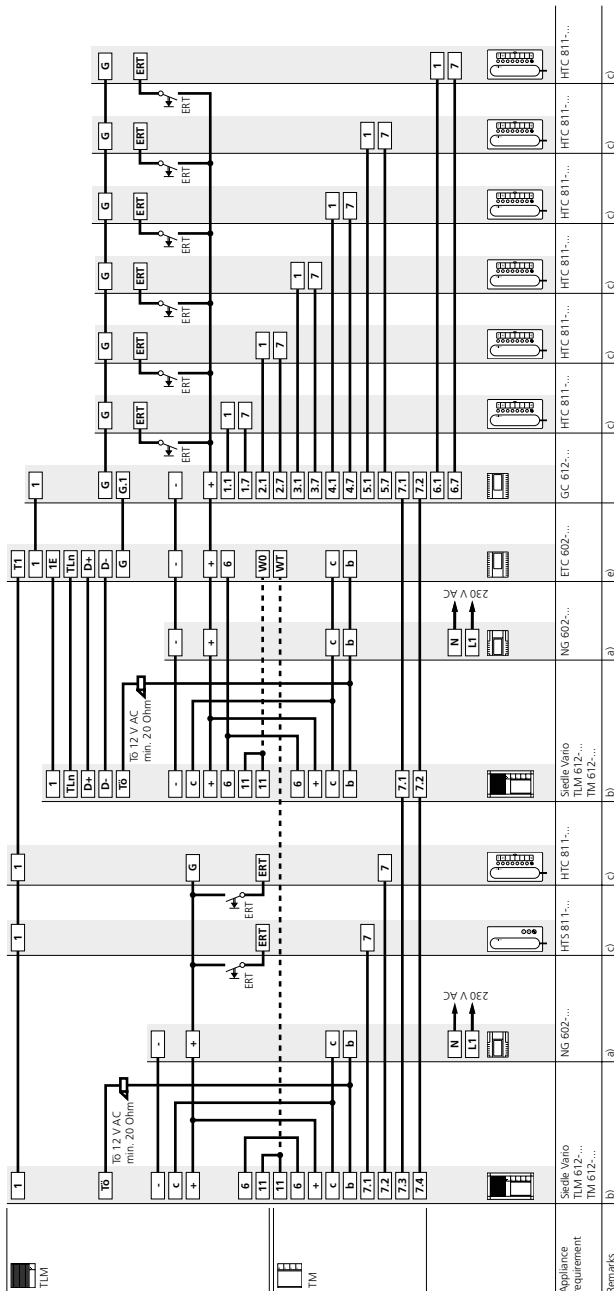

Siedle Vario

1 main door station, 1 storey door station, internal speech communication

Functional

Calling and speech between the door station and connected in-house telephones HTS/HTC 811-...

An existing call cannot be listened in to from other in-house telephones.

Internal speech communication between the HTC 811-..., which is connected to the GC 612-... Dialling the user with the call buttons on the telephones. The assignment sequence corresponds to the sequence of call buttons.

Door release button for the door release function, light button for the light switching function. Illuminated light button at the door station with potential-free switching contact. Storey door station for the functions calling, speech and door release from one storey door station. Several storey door stations can be connected in parallel.

Connection of a storey call button (ERT) for placing calls from an additional door is possible, but not yet indicated in this wiring diagram. Different ringtones for calls from the front door, apartment door and for internal calls.

Call tones with HTS 811-...

On a door call/storey call, a 3-tone call sounds. When calling from a storey call button ERT a 2-tone call sounds.

Call tones with HTC 811-...

On a door call, a 3-tone call sounds, on a storey call the 3-tone chime, without connecting terminal G a 3-tone call. When calling from a storey call button ERT a 2-tone call sounds. HTC 811-... units connected to the GC 612-... signal the first two tones of the 3-tone chime on a call from the storey door station, an internal call is signalled by a 3-tone call.

Connection of additional in-house telephones or door stations possible without switchover device. To ensure tamper-proof connection of the door release, the door release controller CTÖ 602-... has to be used. Additional cores are required for this.

Supplementary functions

• Switching and control functions

are possible with the switching/remote controller SFC 602-...

• A **secondary signal unit** NS 711-... is possible in parallel with an in-house telephone HTS/HTC 811-...

• A **parallel door call** to a maximum of 2 HTS/HTC 811-... units or NSC 602-.../NS 711-... is possible simultaneously.

Remarks

- a) Line rectifier NG 602-... can supply 1 door release and a maximum of 50 call button modules with LED lighting TM 612-1, -2, -3, and -4. With more than 50 illuminated call button modules, an additional TR 603-... is required.
- Door release contact load in the door loudspeaker max. 24 V, 2 A
 - Light contact load in the door loudspeaker max. 24 V, 2 A
- b) Door release 12 V AC, use at least 20 Ohm (e.g. TÖ 615-...).
- LED lighting per call button 20 mA
- c) Conductor length from the in-house telephone to the storey call button ERT max. 50 m/164 ft.
- e) If an in-house telephone is only connected to one storey door station, the dotted connection must be made from terminal 11 at the main door loudspeaker to terminal WT of the storey controller ETC 602-... In addition, the connection is required from terminal W0 ETC 602-... to terminal 11 storey door station.
- f) In the in-house telephones HTC 811-... DIL switch 5 must be set to OFF.
- For more information, see page 44

5 Installation

Siedle Vario, group switching with internal speech communication

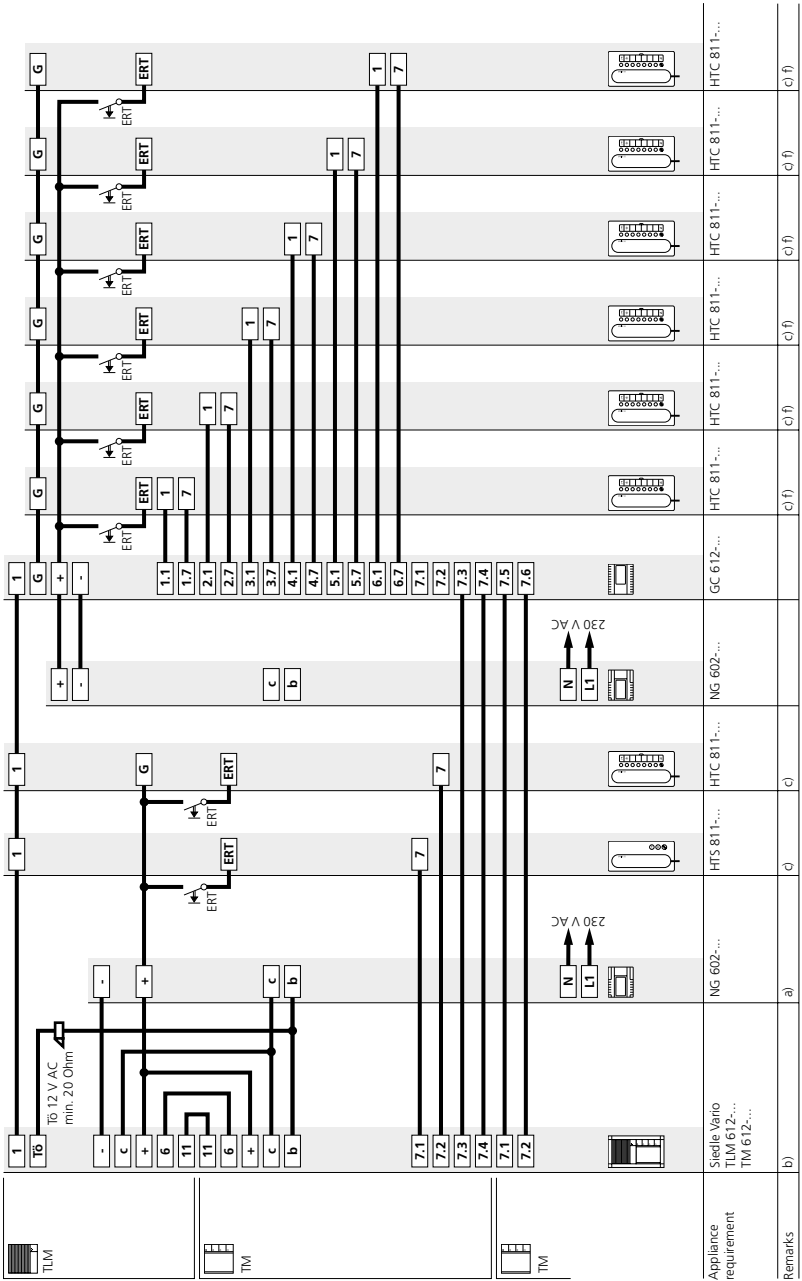

Siedle Vario, group switching with internal speech communication

Functional

Calling and speech between the door station and connected in-house telephones HTS/HTC 811-... An existing call cannot be listened in to from other in-house telephones. Internal speech communication between the HTC 811-..., which is connected to the GC 612-... Dialling the user with the call buttons on the telephones. The assignment sequence corresponds to the sequence of call buttons.

Door release button for the door release function, light button for the light switching function. Illuminated light button at the door station with potential-free switching contact. Connection of a storey call button (ERT) for calling from an apartment door.

Different ringtones for calls from the front door, apartment door and for internal calls.

Call tones with HTS 811-...

A call from the door produces a 3-tone call, from the storey door a 2-tone call.

Call tones with HTC 811-...

On a door call, a 3-tone chime sounds, without connection of terminal G a 3-tone call. A storey call produces a 2-tone call, an internal call a 3-tone call.

Connection of additional in-house telephones or door stations possible without switchover device. To ensure tamper-proof connection of the door release, the door release controller CTÖ 602-... has to be used. Additional cores are required for this.

Supplementary functions

• **Switching and control functions** are possible with the switching/remote controller SFC 602-...

• A **secondary signal unit** NS 711-... is possible in parallel with an in-house telephone HTS/HTC 811-...

• A **parallel door call** to a maximum of 2 HTS/HTC 811-... units or NSC 602-.../NS 711-... is possible simultaneously.

Remarks

- a)** Line rectifier NG 602-... can supply 1 door release and a maximum of 50 call button modules with LED lighting TM 612-1, -2, -3, and -4. With more than 50 illuminated call button modules, an additional TR 603-... is required.
- Door release contact load in the door loudspeaker max. 24 V, 2 A
 - Light contact load in the door loudspeaker max. 24 V, 2 A
- b)** Door release 12 V AC, use at least 20 Ohm (e.g. TÖ 615-...).
- LED lighting per call button 20 mA
- c)** Conductor length from the in-house telephone to the storey call button ERT max. 50 m/164 ft.
- f)** In the in-house telephones HTC 811-... DIL switch 5 must be set to OFF.
- For more information, see page 44

6 Supplementary functions

Group controller GC 612-...

The group controller GC 612-... in the 6-grid housing is used for the connection of a group of max. 6 in-house telephones HTC 811-... In-house telephones connected to the group controller the buttons 1–6 can be used to call and communicate with other in-house telephones. The door station is switched off during an internal call. With the GC 612-... it is also possible to signal a door call to more than 2 in-house telephones. For this function HTS 811-... units can also be used.

Several group controllers can be used in an intercom unit. In addition, switching and control functions can be executed from every connected in-house telephone HTC 811-... If a door call is made to an in-house telephone which is currently conducting a call, this is interrupted and an engaged signal sounds. After replacing the receiver the door call is signalled.

Call differentiation HTC 811-...

Main door call: 3-tone chime, storey door call: 1st and 2nd chime tone of the three-tone chime, sub-sequently normal 3-tone chime
Internal call: 3-tone call
Storey call: 2-tone call (ERT button connected directly at the HTC)

Door parallel call

The door call can be signalled simultaneously in conventional systems at up to 2 in-house telephones. With the GC 612-... it is possible to signal a door call at up to 6 in-house telephones. This always actuates two in-house telephones simultaneously. With more than two parallel telephones, these are always called in pairs with a time offset.

Speech connection

For each group controller, only one call can be held. If an internal call already exists within a group, it is possible to place an additional call from the door loudspeaker only to another in-house telephone which is not directly connected to the GC 612-... The group controller acts in relation to the 1+n side circuit installation in the same way as an in-house telephone. Each GC 612-... requires the NG 602-... for its own power supply.

Switching and control functions

Switching and control functions are possible in conjunction with the SFC 602-... A maximum of 6 control functions can be actuated from each HTC 811-... in the group. Control functions can be executed at any time with the receiver down or during an existing speech connection. Settings at DIL switch 2 may be necessary in the in-house telephones HTC 811-...

Operating elements GC 612-...

- One programming switch in order to enable the programming mode
- One status LED to display the programming mode and saving.
- 8 DIL switches to determine the required functions/for programming.
- DIL switches 1–6 for assignment of the door call to the in-house telephones 1 to 6

DIL switch 7

ON SFC 602-... is connected at the group controller

OFF SFC 602-... is connected at the door loudspeaker

If DIL switch 7 is set to OFF, DIL switch 8 is non functional.

DIL switch 8

ON Control functions 5 and 6 act on the SFC 602-... at the door loudspeaker

OFF Control functions 5 and 6 act on the SFC 602-... at the group controller

Internal call

From each HTC 811-... unit in the group, each other in-house telephone of **the same** group can be called. The following procedure has to be observed here: Pick up the receiver and only then actuate the required call button at the in-house telephone.

Secondary signal unit

For door call 1 (terminal 7.1) a potential-free contact S1/S2 is available at the GC 612-... (max. 24 V, 2 A).

Installation

The in-house telephones at the GC 612-... are installed in star formation.

Maximum conductor lengths between:

- GC 612-... and telephones 100 m/328 ft
- GC 612-... and door station 500 m/1640 ft

For more information, see page 36

As-delivered status of the GC 612-...

The door call inputs are assigned to telephones 1:1.

Terminal 7.1 (input 1) is assigned to the 1st telephone, terminal 7.6 (input 6) to the 6th telephone.

Assignment of door call inputs
7.1–7.6 to in-house telephones 1–6.

When reprogramming door calls, the same applies to new programming, i.e. the existing programming is overwritten.

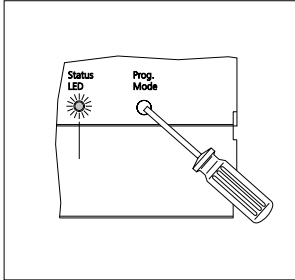

1 Activate the programming mode at the GC 612-..., the status LED starts to flash.

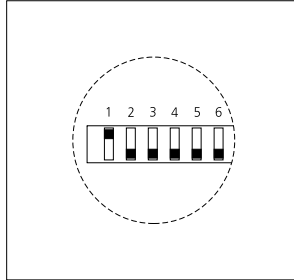

2 Select the relevant telephone using the DIL switch e.g. telephone 1 (DIL 1 ON). Several DIL switches can be used.

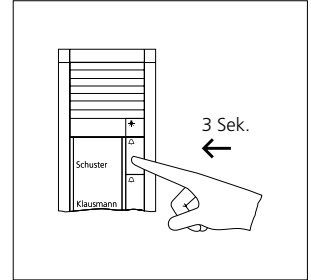

3 Hold down the call button you wish to assign to one or more in-house telephones for 3 seconds. (e.g. door call 1 to telephone 1).

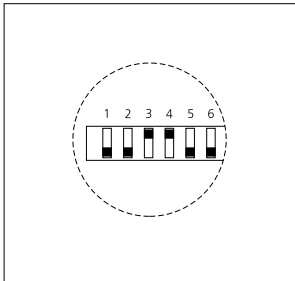

4 Select the telephones (e.g. telephone 3 and 4) you wish to assign to the next door call.

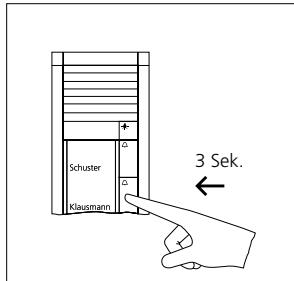

5 The call button you wish to assign to the telephone should be held down for 3 seconds (e.g. door call 2 to telephones 3 and 4). Program other call inputs using the same procedure. Once all the telephones have been assigned, terminate the programming mode.

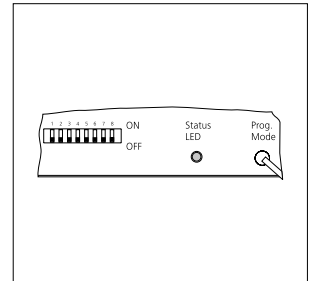

6 Press the programming mode button to terminate the programming session.

6 Supplementary functions

Switching/remote controller SFC 602-...

The switching/remote controller in a 3-grid housing is used to execute a maximum of 4 central switching and control functions (connection to the door loudspeaker) or 4 local switching and control functions (connection to group controller). Actuation can take place via the door release or light button and also using keys 1–6 from in-house telephones HTC 811-...

Functions of the SFC 602-...

- 1 relay with potential-free changeover contact and 3 relays with one potential-free working contact each. The 4 relays can be individually set as switches or buttons.

Setting

- 6 DIL switches for setting the functions and for relay assignment to the buttons in the in-house telephones.
- 1 rotary switch for setting the switching time, when relays 1 and 2 are used as timers. The time can be set in 10 steps of 3 seconds each

up to 20 minutes. If relays 3 and 4 are set as timers, the time is fixed at 3 seconds.

Installation

Connection of the SFC 602-... takes place via terminals D+ and D- at a door loudspeaker module TLM 612-.../TLE 061-... When connecting to a controller GC 612-... or ETC 602-... only the telephones connected to the controller can initiate switching and control functions. When connecting to a door loudspeaker, the functions are possible from all connected telephones.

In a 1+n system a maximum of 2 SFC 602-... or 2 CTÖ 602-... units can be connected per door loudspeaker. A mixture of SFC 602-... and CTÖ 602-... units is possible.

Specifications

Operating voltage: 12 V AC
Operating current: max. 250 mA
Contact type: 1 changeover switch 24 V, 2 A; 3 n.o. contacts 24 V, 2 A
Switching time: 2 x adjustable from 3 sec to 20 min and 2 x fixed at 3 sec
Horizontal pitch (HP): 3
Dimensions (mm) W x H x D: 53.5 x 89 x 60

Position of the DIP switches

Function assignment for relays 1–4

DIL switch	Position	Function	Relay	Comments
1, 2	OFF/OFF	Button for	1, 2	Time for both adjustable from 3 seconds to 20 minutes
3, 4	OFF/OFF	Button for	3, 4	Time for both fixed at 3 seconds
1 – 4	ON	Switch	1 – 4	Switch ON/OFF

Button assignment in the HTC 811-...

DIL switch	Position	Relay	Actuation by button
A, B	OFF/OFF	1, 2, 3, 4	1, 2, 3, 4
A, B	ON/OFF	1, 2, 3, 4	3, 4, 5, 6
A, B	OFF/ON	1, 2, 3, 4	1, Li, 2, Tö
A, B	ON/ON	1, 2, 3, 4	5, Li, 6, Tö

If the light (Li) and door release (Dr) button are used in the in-house telephone for actuation of the relays in the SFC 602-..., the DIL switches 2 and 4 should be set to OFF to ensure that the timer function is activated!

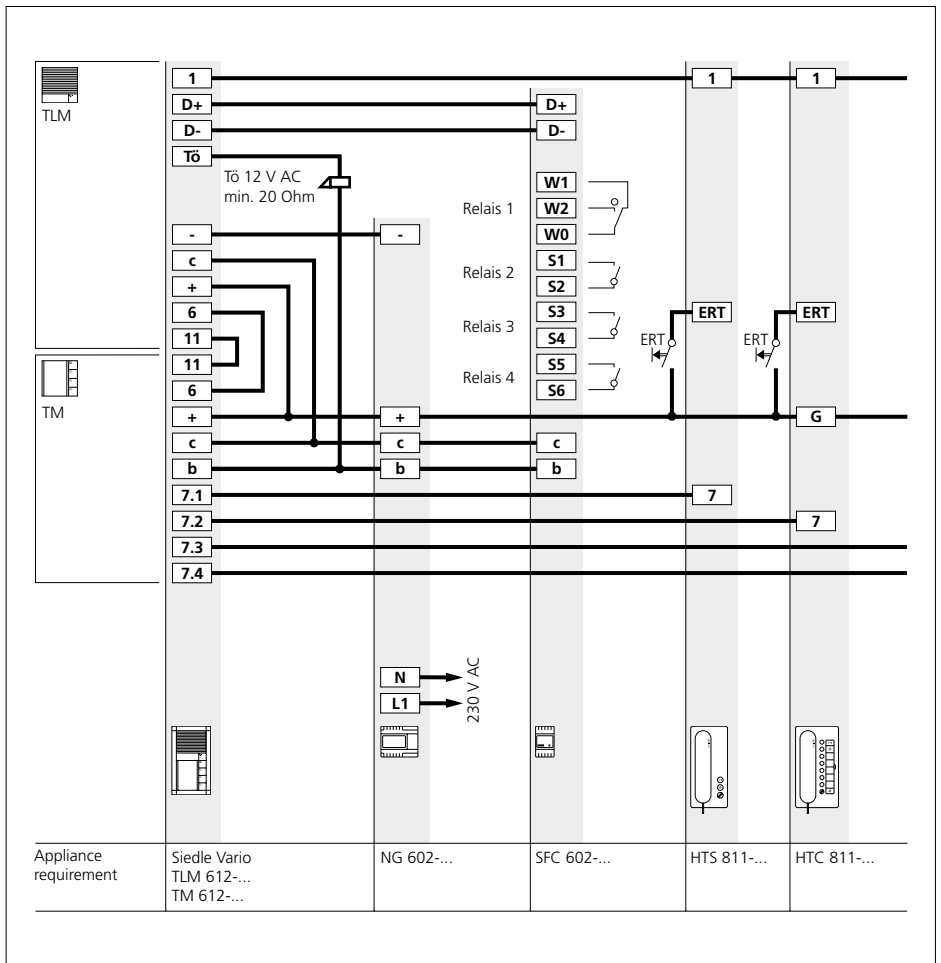

Connection of an SFC 602-...
 All connected in-house telephones
 can initiate switching functions of
 the SFC 602-...

6 Supplementary functions

Storey controller ETC 602-...

The storey controller in the 6-grid housing is used to connect a storey door station. Up to a maximum of 7 storey door stations can be connected to a storey controller. In addition to a call with the main door station in the side circuit, a call is also possible from a storey door station to an in-house telephone. If a call exists from a storey door station, it is not possible to place a call to any of the other in-house telephones connected to the ETC 602-... If you wish as many simultaneous calls to be possible as there are storey door loudspeakers, for each storey door loudspeaker 1 ETC 602-... with an NG 602-... is required. In addition, a call can be held from a main (side circuit) door loudspeaker to a free storey, i.e. several calls are possible simultaneously.

If you require an additional internal speech facility between the connected in-house telephones at the storey controller, a group controller GC 612-... and in-house telephones HTC 811-... (max. 6) must be used in addition. In parallel with every ETC 602-... it is possible to connect a switching/remote controller SFC 602-... to the storey door loudspeaker(s). All calls have audio privacy. When using the HTS 811-... no call differentiation between the main (side circuit) door loudspeaker and storey door loudspeaker is possible!

Call differentiation HTC 811-... at ETC 602-...

Main (side circuit) door call:
3-tone call
Storey door call: 3-tone chime

Call differentiation HTC 811-... at ETC 602-... with GC 612-...

Main door call: 3-tone chime
Storey door call: 1st and 2nd chime tone of the three-tone chime, subsequently normal 3-tone chime
Internal call: 3-tone call

Function

After a completed call from a storey door station, this remains switched on at the called in-house telephone for 30 seconds. If no receiver is lifted during this period, the connected in-house telephones on the storey level are switched on again at the main door station. Actuation of the storey door release, the storey light and the storey SFC 602-... is **only possible during a connection to the storey**. After replacing the receiver, the telephones are switched on again at the main door loudspeaker(s) after around 10 seconds. Outside a storey call, the door release and light relay of the **last called main (side circuit) door loudspeaker** and any connected SFC/CTÖ 602-... are **always** actuated. The storey controller ETC 602-... is fitted with a potential-free switchover contact (WT/W0/WE).

Secondary signal controller NSC 602-...

Using the secondary signal controller NSC 602-... an additional secondary signal unit or a radio chime can be actuated in parallel with the door and storey call. There are 2 potential-free work contacts available for this purpose which have a common reference point. The NSC 602-... can be mounted/inserted in a size 55 switch box under the telephone or offset in a junction box.

The secondary signal controller behaves in the same way as an in-house telephone connected in parallel, i.e. it is not possible to connect an additional telephone in parallel.

Specifications

Contact type: 2 n.o. contacts,
max. 24 V, 1 A

Ambient temperature:

0 °C to +40 °C

Protection system: IP 20

Dimensions (mm) dia. x H: 51 x 23

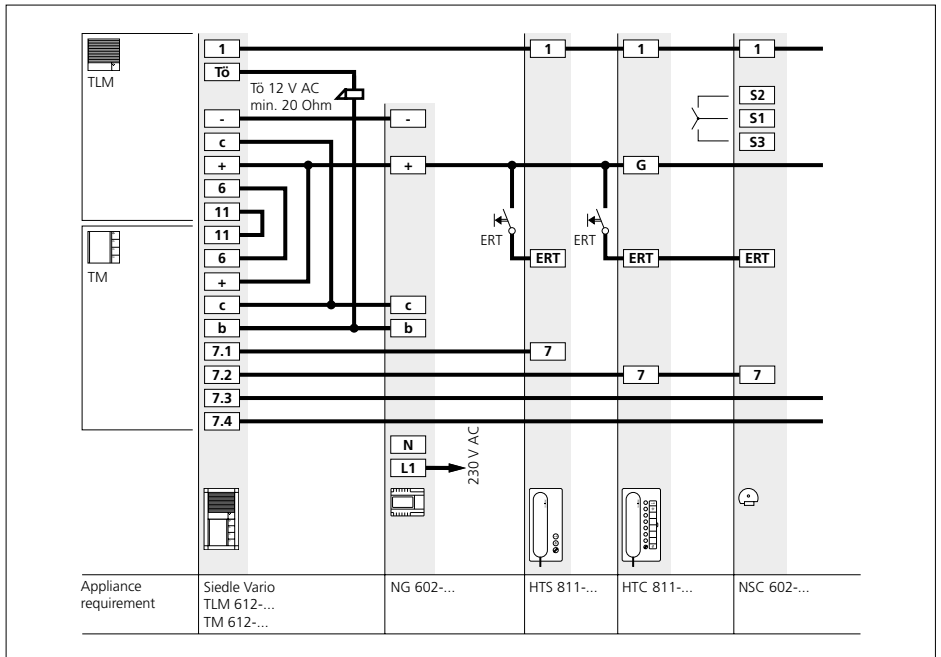
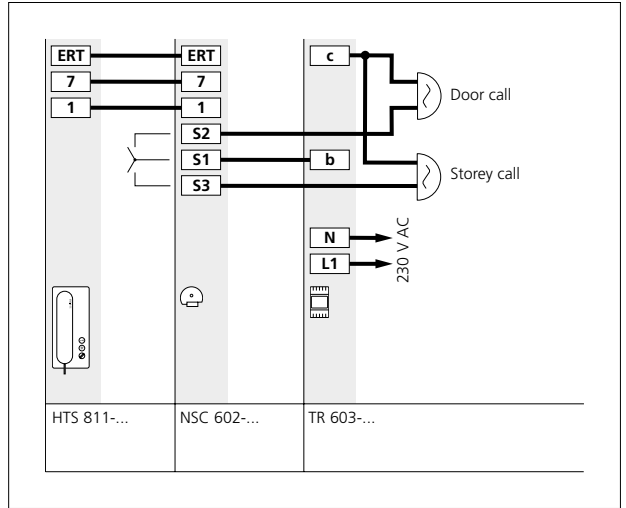

6 Supplementary functions

Controller door release CTÖ 602-...

The controller door release CTÖ 602-... is used to actuate a door release from the subdistributor. This installation is used if the connecting wires are not connected in the housing of the door station for safety reasons. Connection of the CTÖ 602-... takes place at junctions D+/D- of the Siedle door loudspeaker TLM 612-... or TLE 061-...

For selective actuation of the door release, one CTÖ 602-... is required per door loudspeaker.

Specifications

Operating voltage: 12 V AC
 Operating current: max. 70 mA
 Contact type: contact 24 V, 2 A
 Switching time: Fixed at 3 sec
 Protection system: IP 20
 Ambient temperature: 0 °C to +40 °C
 Horizontal pitch (HP): 3
 Dimensions (mm) W x H x D: 53.5 x 89 x 60

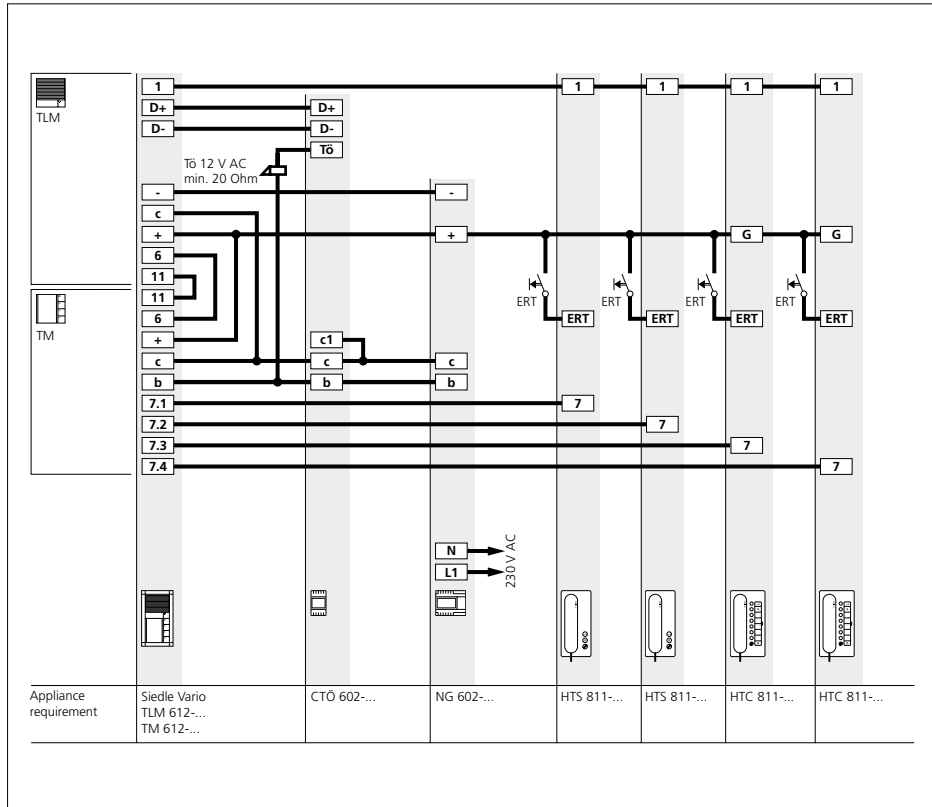

Both door releases have a tamper-proof connection.

For more information, see page 32

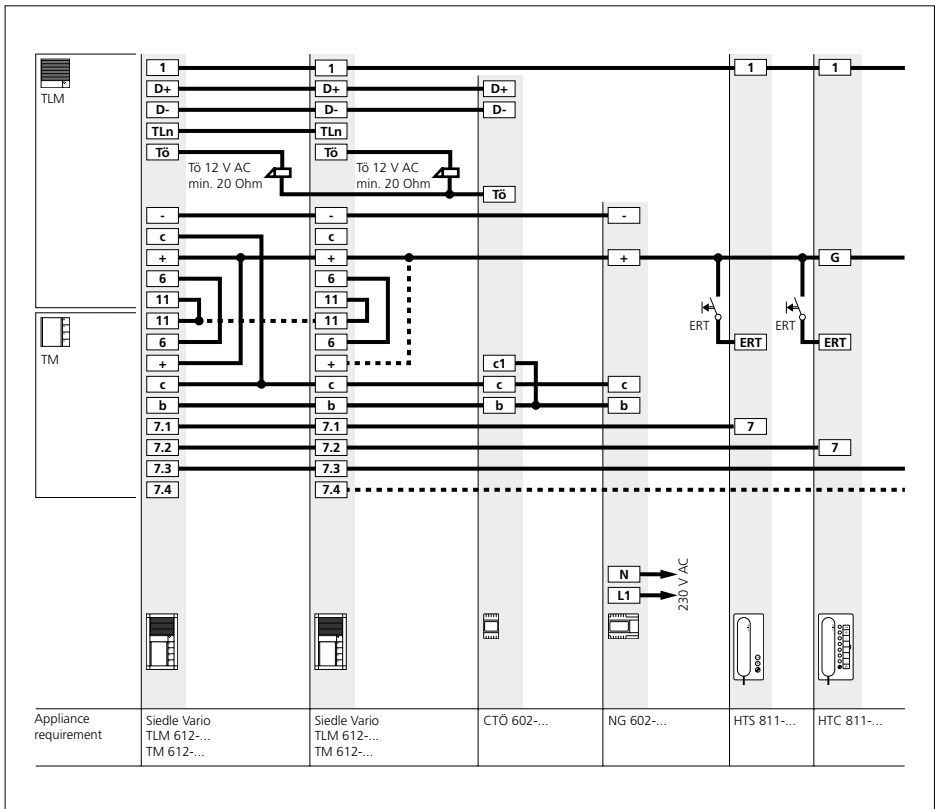

6 Supplementary functions

Parallel switching in-house telephones

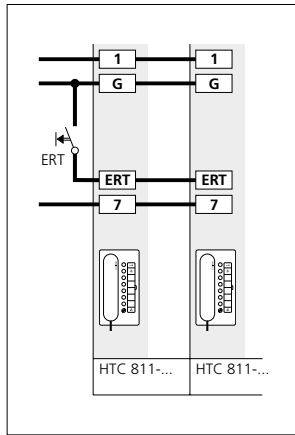
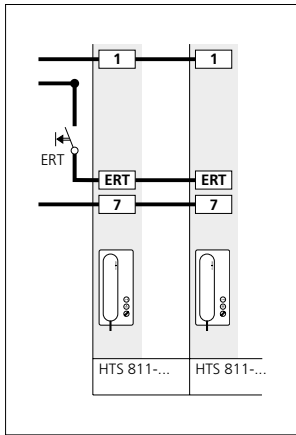

Parallel switching HTS/ HTC 811-...

Using 1+n technology, a maximum of 2 in-house telephones can be operated in parallel. Accessories NSC 602-... and NS 711-... also count as parallel devices.

Via a GC 612-... it is possible to call up to 6 in-house telephones in parallel. The GC 612-... must be programmed accordingly for this function.

The range is reduced in the event that two in-house telephones are switched in parallel:

HTS 811-...	250 m
HTC 811-...	250 m

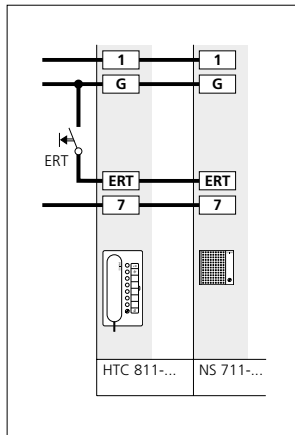
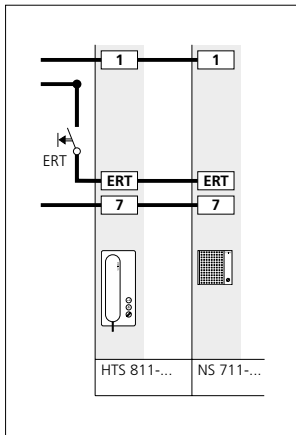

Secondary signal unit NS 711-...

Instead of a second in-house telephone it is also possible to operate a secondary signal unit NS 711-... in parallel. The NS 711-... signals a door and storey call with call differentiation. When connecting terminal G the door call is signalled as a three-tone chime.

Conductor length from the in-house telephone to the storey call button ERT max. 50 m/164 ft.

Pilfer safeguard DSC 602-...

Pilfer safeguard for Vario modules

Bistable magnet for integration in mounting frame MR 611-...

Application

To secure valuable modules such as camera modules, code lock modules or to ensure tamper-proof operation of the door release.

A stable metal plate locks the opening mechanism and prevents modules from being removed. The magnets are opened and locked in the sub-distributor at pilfer safeguard controller DSC 602-... A maximum of 2 ZDS 601-... units can be operated at one DSC 602-...

Range

Maximum conductor length between DSC 602-... and ZDS 601-... with 0.8 mm core diameter 100 m/328 ft.

With Siedle-Steel, the pilfer safeguard controller SDSC 602-01 is required.

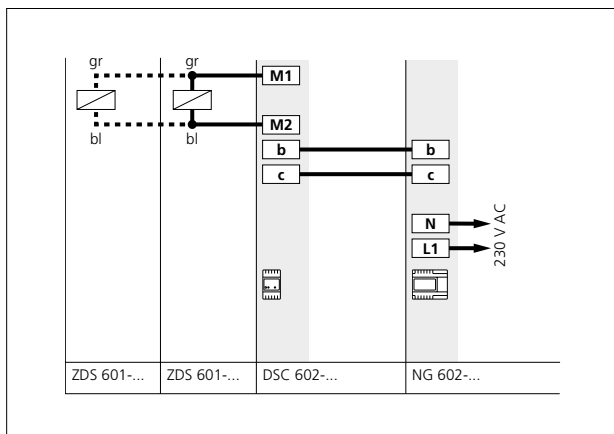

6 Supplementary functions

Staircase light/Outside light

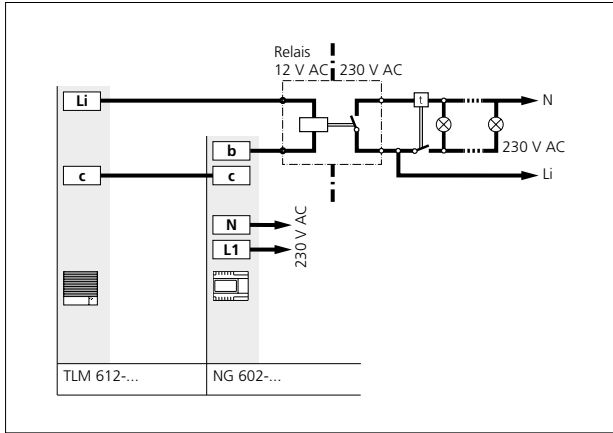

Light actuation

Using the light button in in-house telephones HTS/HTC 811-... the light contact is closed in the door loudspeaker for 0.8 seconds. The reference for this contact is terminal c. Pick-up at terminal Li.

Following completion of the installation, this function is active without any further programming. To actuate the staircase and/or outside light, in accordance with the VDE regulations a light current or time relay must be interconnected.

In addition, it is possible to switch the outside or inside light with the light button in the door loudspeaker module. Pick-up of the button takes place at terminals T1 and T2 at the door loudspeaker module.

LED actuation, potential-free buttons

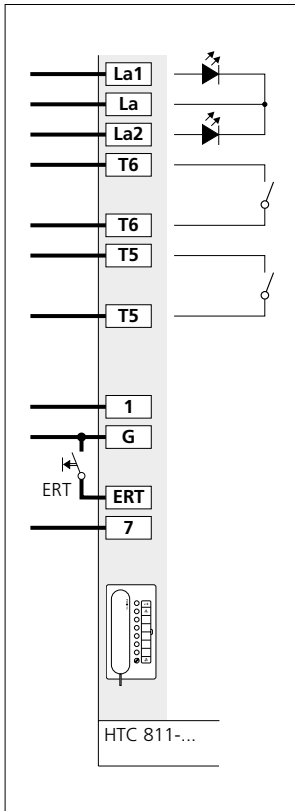

LEDs

The in-house telephones HTC 811-... are equipped with two LEDs. The LEDs are located under the buttons 3 and 4, actuation can take place using direct or alternating voltage.

- La1 and La2:
10–15 V AC, max. 10 mA
- La1 and La2:
15 V DC, max. 10 mA, observe polarity

Application

Open garage door
Open front door
Error message

Buttons

In the as-delivered status, buttons 5 and 6 transmit the information directly via cores 1 and 7. Using switch block DIL2 in the in-house telephones HTC 811-..., buttons 5 and/or 6 can be switched to potential-free. The max. button load is 15 V AC, 30 V DC, 2 A in each case.

Application

Additional door release
Garage door open/shut
Actuation of current surge relay

6 Supplementary functions

Exchange/extension

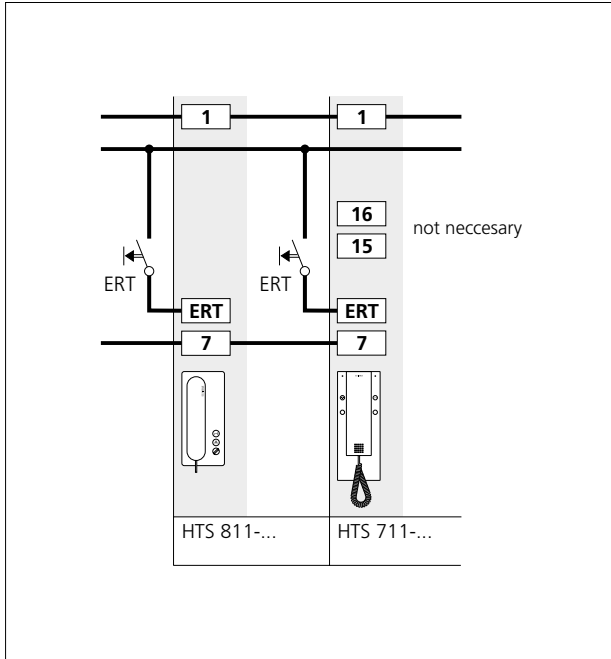

The in-house telephones HTS/HTC 811-... can be used in existing 1+n systems with the predecessor models HTS/HTC 711-... units for HTS/HTC 811-... units is possible.

The terminal designations of the in-house telephones are identical. The HTC 811-... deviates from the HTC 711-... in as far as the light button can optionally be used as button 1. Switchover takes place via a DIL switch in the in-house telephone HTC 811-...

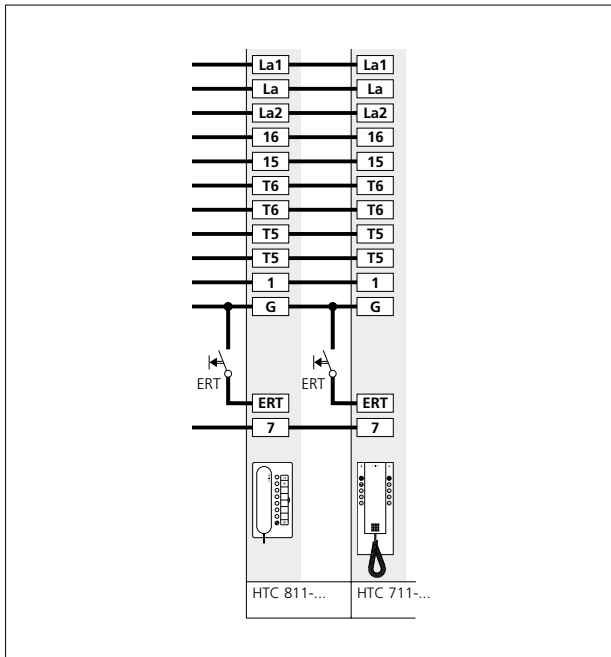

Comparison HTC 811-.../
HTC 711-...

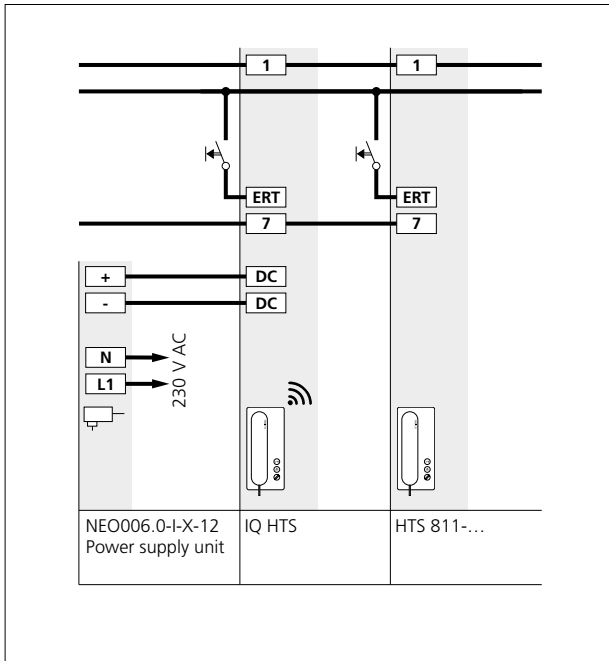

The IQ HTS in-house telephone can replace the HTS 711/811-... models in 1+n-systems.

The terminal designations for the in-house telephones are identical.

Additional power supply required for the IQ HTS indoor station.

As an alternative to the power supply unit, the PSM 1 12 24 line rectifier can be used for the central supply, this supplies a maximum of 2 IQ in-house telephones.

If the operating voltage is not connected, the door release and WLAN interfaces will not work.

7 Servicing

Measured values

Measured values in the 1+n system, for measurement using a digital multimeter

Idle status	Voltage door station Terminal 1 and 7...	Voltage in-house telephone Terminal 1 and 7
OK	17 – 19 V DC	17 – 19 V DC, 50 µA
No in-house telephone connected, core interrupted, in-house telephone defective	22 – 24 V DC	0 V DC
Terminal + at call button module or diode accessory missing In-house telephone has already been called and is active	14 – 16 V DC	14 – 16 V DC, 50 µA 14 – 16 V DC, >10 mA
Cores to in-house telephone under load or connected to an external device	<14 V DC	<14 V DC
Call status		
OK	22 – 24 V DC, 150 mA	>18 V DC, max. 150 mA
No in-house telephone connected	24 V DC	---
Short circuit between terminal 1 and 7	<8 V DC	0 V DC
Speech mode		
OK, speech connection exists	14 – 16 V DC	14 – 16 V DC, >20 mA
OK, receiver not lifted within 30 seconds after call	14 – 16 V DC	14 – 16 V DC, 10 – 15 mA
In-house telephone has not been called from the door Last door call longer than 30 seconds ago	16 – 18 V DC	16 – 18 V DC, 50 µA
No in-house telephone connected	22 – 24 V DC	---
Cores to in-house telephone under load or connected to an external device	<14 V DC	<14 V DC
Intercom system with more than 1 door station		
OK	appr. 6 V DC	
Connection to SFC 602-... or CTÖ 602-...		
Connecting cores D+/D- OK	appr. 14 V DC	appr. 14 V DC
SFC/CTÖ not responding, D+/D- cores interchanged	appr. -14 V DC	appr. -14 V DC
SFC/CTÖ not responding, D+/D- cores interrupted	appr. 14 V DC	0 V DC
SFC/CTÖ not responding, D+/D- cores short circuited	0 V DC	0 V DC

8 Glossary, Index

Outside light	54	CL A xx N	9, 24
Exchange	56	CTÖ 602-...	12, 50
Classic	9, 24	DCA 612-...	13, 28
Diode accessory	9	DSC 602-...	53
DoorCom-Analog	13, 28	ETC 602-...	12, 38
Storey controller	12, 48	GC 612-...	10, 36
Storey call	6	HTC 711-...	56
Troubleshooting	58	HTC 811-...	14
Comparison	56	HTS 711-...	56
Group controller	10, 36	HTS 811-...	14
Internal speech	36	IQ HTS	14, 57
Internal call	36, 40	NEO006.0-I-X-12	11, 57
Terminal block	16	NG 602-...	10
LED actuation	55	NG 706-30/33-...	11
LED display	55	NS 711-...	15, 52
Conductor length	4	NSC 602-...	13, 49
Light button	6	PSM 1 12 24	11
Measured values	58	SFC 602-...	12, 46
Secondary signal controller	6, 13, 49	STL	9, 26
Secondary signal unit	6, 15, 52	TLE 061-...	8, 22
Parallel switching	52	TLM 612-...	8, 20
Potential-free button	55	TM 612-...	8, 20
Range	4, 53	TR 603-...	10
Switching/ remote controller	6, 12, 46	ZD 061-...	9, 22
Servicing	58	ZDS 601-...	53
Steel	9, 26	ZTC 800-...	15
Control functions	46, 55	ZTS 800-...	15
Door loudspeaker	8, 16		
Door release	6		
Time for light contact	6		

Technical additions or printing errors do not constitute grounds for compensation claims.

To supplement this system manual, you will find the latest edition in the download area of our website on www.siedle.com

Customer service at the Furtwangen plant
+49 7723 63-434

SSS SIEDLE

S. Siedle & Söhne
Telefon- und Telegrafentechnik OHG

Postfach 1155
78113 Furtwangen
Bregstraße 1
78120 Furtwangen

Telefon +49 7723 63-0
Telefax +49 7723 63-300
www.siedle.de
info@siedle.de

© 2006/09.22
Printed in Germany
Best. Nr. 210011886-00 EN (PDF)