

Flush-mount housing
Siedle Classic
GU CL 10-0

210007746-00



Product description

Housing for flush-mounting made of hot-dip galvanized sheet steel.

Matching housing must be ordered for each front panel.

Specifications

Dimensions (mm) W x H x D: 154 x 468 x 65

Article information

Article designation	Article description	Colour/Material	KGSAP article no.
GU CL 10-0	Flush-mount housing Siedle Classic	Hot-dip galvanized sheet steel	D 210007746-00



Flush-mount housing
Siedle Classic
GU CL 10-0

210007746

Page 2

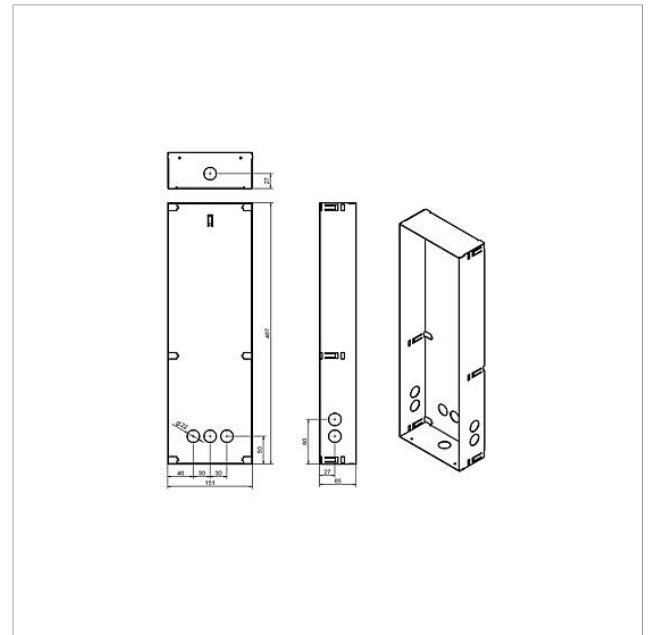



Flush-mount housing
Siedle Classic
GU CL 10-0

210007746

Page 3

Siedle Classic Flush-mount housing

Product information

718 kB

[Download](#)

Declaration of Conformity

140 kB

[Download](#)

Additional information

140 kB

[Download](#)