

Indmuringsdåse Siedle
Classic
GU CL 10-0

210007746-00



Produktbeskrivelse

Kabinetter til indmuret montage af varmgalvaniseret stålblek.

Et passende kabinet skal bestilles til hver frontplade.

Tekniske specifikationer

Mål (mm) b x h x d: 154 x 468 x 65

Artikelinformationer

Artikler-betegnelse	Varebeskrivelse	Farve	KGVarenr.
GU CL 10-0	Indmuringsdåse Siedle Classic	Stålplade galvaniseret	D 210007746-00



Indmuringsdåse Siedle
Classic
GU CL 10-0

210007746

Side 2

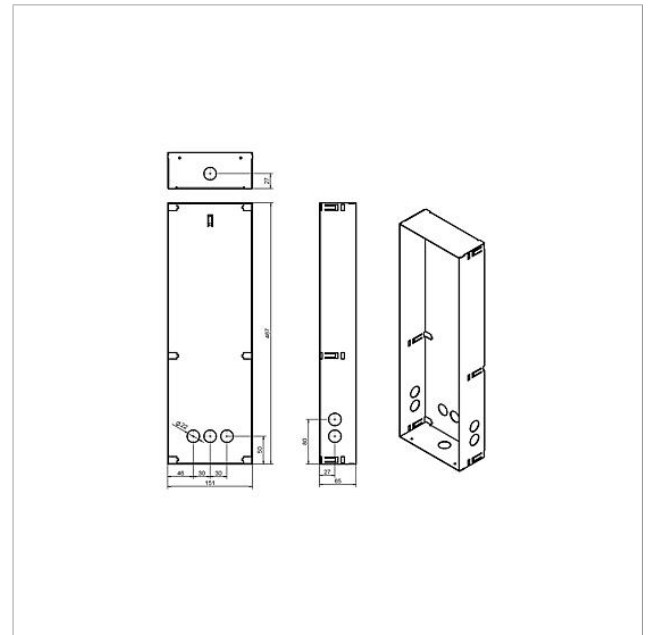



Indmuringsdåse Siedle
Classic
GU CL 10-0

210007746

Side 3

Siedle Classic Indmuringsdåse

Produktinformation

718 kB

[download](#)

Overensstemmelseserklæring

140 kB

[download](#)

Ekstra information

420 kB

[download](#)