

Flush-mount housing  
Siedle Classic  
GU CL 04-0

210007734-00



## Product description

Housing for flush-mounting made of hot-dip galvanised sheet steel.

Matching housing must be ordered for each front panel.

## Specifications

Dimensions (mm) W x H x D: 154 x 283 x 65

## Article information

Article designation	Article description	Colour/Material	KGSAP article no.
GU CL 04-0	Flush-mount housing Siedle Classic	Hot-dip galvanized sheet steel	D 210007734-00

## Accessories

Article designation	Article description	Colour/Material	KG	SAP article no.
F CL A 04 B-0	Function unit audio door station Siedle Classic	Brushed stainless steel	D	210007707-00
F CL A 04 N-0	Function unit audio door station Siedle Classic	Brushed stainless steel	D	210007708-00
F CL A 04 R-0	Function unit audio door station Siedle Classic	Brushed stainless steel	D	210007709-00



Flush-mount housing  
Siedle Classic  
GU CL 04-0

210007734

Page 2

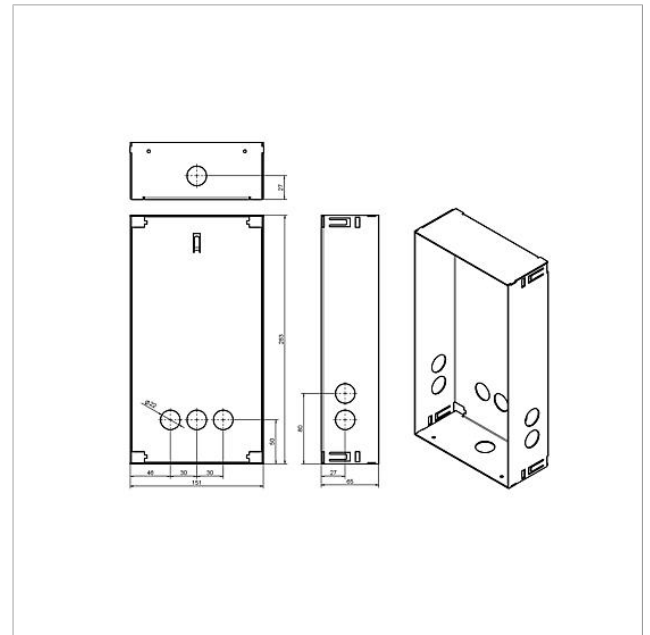



Flush-mount housing  
Siedle Classic  
GU CL 04-0

210007734

Page 3

---

Siedle Classic Flush-mount housing

Product information

1,1 MB

[Download](#)

Declaration of Conformity

140 kB

[Download](#)

Additional information

140 kB

[Download](#)