



Access in-house
telephone
AHT 870-0 A/S
200042031-00

Product description

Access in-house telephone with door release button and 7 additional buttons with 2-colour status LED. All buttons are freely programmable. The display shows the graphic menu interface, but not a camera image. It is possible to upgrade to a fully functional video station.

With the functions calling, speech, door release, light, remote switching and call barring.

With the additional purchase of the AUV 870-... T, the AHT 870-... can be transformed into a fully valid video indoor device.

Performance features:

- Display 8.8 cm
- Input for storey call
- Output freely programmable
- Call differentiation between door calls, storey calls, and internal calls
- Switching functions
- Status messages
- Can be used with table-top accessory AZTV 870-... as a table-top device

Specifications

Operating voltage:	PoE in accordance with 802.3af
Ambient temperature:	+5 °C to +40 °C
Dimensions (mm) W x H x D:	106 x 278 x 51

Article information

Article designation	Article description	Colour/Material	KG SAP article no.
AHT 870-0 A/S	Access in-house telephone	Aluminium/black	F 200042031-00

Accessories

Article designation	Article description	Colour/Material	KG	SAP article no.
AUV 870-0 T	Access for video upgrade	White	F	200087907-00
AZA 870-0 S	Access surface-mount accessory	Black	F	200041779-00
AZIO 870-0	Access input/output accessory	Others	F	200041846-00
AZTV 870-0 S	Access table-top accessory	Black	F	200041336-00



Access in-house
telephone
AHT 870-0 A/S

200042031

Page 2

Spare parts

Article designation	Article description	Colour/Material	KG	SAP article no.
BTC/BTCV 850-..., HTC/HTCV 811-..., HT/HTV 840-...	Transparent cover	Clear glass	E	200029578-00
BTCV 850-...	Insert for button functions	White	E	200029576-00
HT 811/840/850/870-... S	Receiver with no-tangle cord	Black	E	200029894-00

Access in-house
telephone
AHT 870-0 A/S

200042031

Page 3

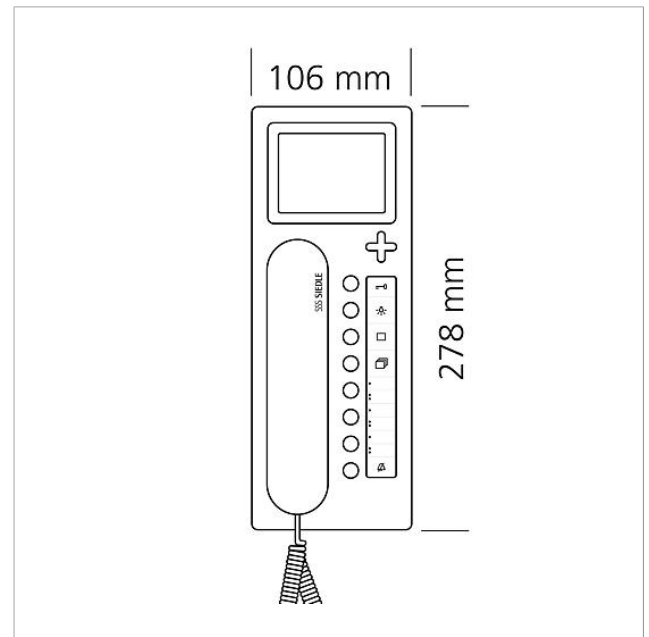



Access in-house
telephone
AHT 870-0 A/S

200042031

Page 4

AHT 870-0 Access in-house telephone	Product information	1,4 MB	Download
AHT/AHTV 870-0 Access in-house telephone	Manual	3,9 MB	Download
AHT 870-..., AHTV 870-0 Access in-house telephone, Access video in-house telephone	Declaration of Conformity	858 kB	Download
	Additional information	140 kB	Download
	Labeling service	0 Bytes	Download