



Access video in-house
telephone
AHTV 870-0 A/S
200041940-00

Product description

Access in-house telephone video with door release button and 7 additional buttons with 2-colour status LED. All buttons are freely programmable. The display shows the camera image and the graphic menu interface.

With the functions calling, speech, door release, vision, light, remote switching and call silencing.

Performance features:

- Display 8.8 cm
- Entrance for storey calls
- Exit freely programmable
- Call differentiation between door calls, storey calls and indoor calls
- Switching functions
- Status indications
- Video memory function
- Integrated 5-way control button
- Can be used with table-top accessory AZTV 870-... as a table-top device

Specifications

Operating voltage:	PoE in accordance with 802.3af
Ambient temperature:	+5 °C to +40 °C
Dimensions (mm) W x H x D:	106 x 278 x 51

Article information

Article designation	Article description	Colour/Material	KG SAP article no.
AHTV 870-0 A/S	Access video in-house telephone	Aluminium/black	F 200041940-00

Accessories

Article designation	Article description	Colour/Material	KG	SAP article no.
AZA 870-0 S	Access surface-mount accessory	Black	F	200041779-00
AZIO 870-0	Access input/output accessory	Others	F	200041846-00
AZTV 870-0 S	Access table-top accessory	Black	F	200041336-00



Access video in-house
telephone
AHTV 870-0 A/S

200041940

Page 2

Spare parts

Article designation	Article description	Colour/Material	KG	SAP article no.
BTC/BTCV 850-..., HTC/HTCV 811-..., HT/HTV 840-...	Transparent cover	Clear glass	E	200029578-00
BTCV 850-...	Insert for button functions	White	E	200029576-00
HT 811/840/850/870-... S	Receiver with no-tangle cord	Black	E	200029894-00

Access video in-house
telephone
AHTV 870-0 A/S

200041940

Page 3

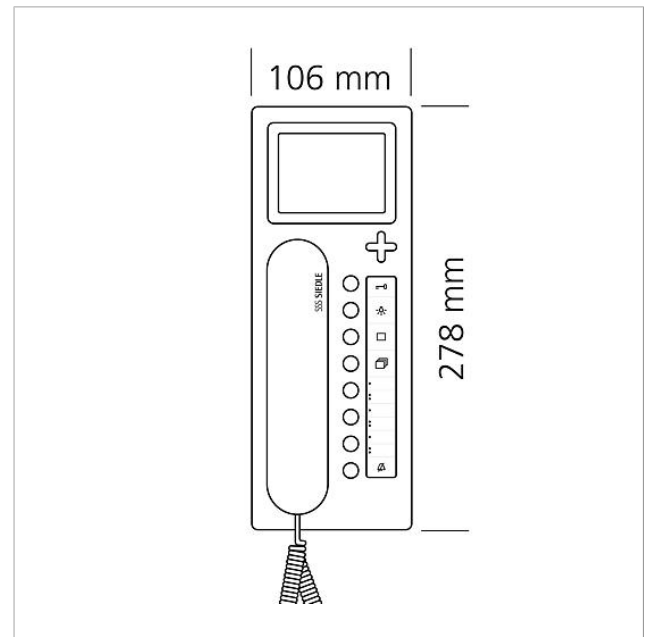



Access video in-house
telephone
AHTV 870-0 A/S

200041940

Page 4

AHTV 870-0 Access video in-house telephone	Product information	1,4 MB	Download
AHT/AHTV 870-0 Access in-house telephone	Manual	3,9 MB	Download
AHT 870-..., AHTV 870-0 Access in-house telephone, Access video in-house telephone	Declaration of Conformity	858 kB	Download
	Additional information	109 kB	Download
	Labeling service	0 Bytes	Download