

Planning and system manual for access control Issue 2023

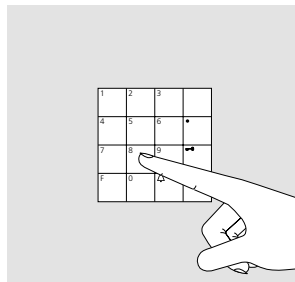
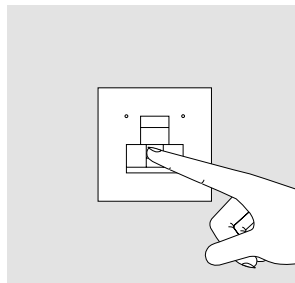
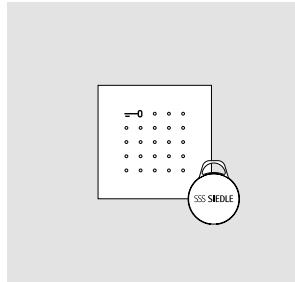

Contents

1 Planning help	4	7.1 Installation EC 602-...	42	8 Programming	65
2 Configuration examples	10	Basic circuit diagram EC 602-...	42	8.1 General	65
3 Function overview	24	Basic circuit diagram EC 602-... + ECE 602-...		8.2 Stand alone operation	65
4 Safety remarks	28	(Maximum configuration)	44	8.3 Operation with entrance controller EC 602-...	66
5 Establishing access control with Vario bus	29	2 Door stations	46	Switching and control functions	68
Installation notes	29	4 Door stations	47	Input block	69
Power supply	30	Access Professional – 1 Door station	48	Internal key button	70
Range	31	Access Professional – 2 Door stations	50	External key button	70
6 System components	34	In-Home bus – 1 Door station (tamper-proof)	52	Gateways / Cascade control for 2 door releases	72
Input/read units	34	In-Home bus – 3 Door stations (not tamper-proof)	54	Feedback input on COM 611-...	73
RFID card / RFID tag (electronic key)	35	In-Home bus – 3 Door stations (tamper-proof)	56	8.4 Operation with Secure Controller SC 600-...	74
6.1 System components EC 602-...	36	In-Home bus – 3 Door stations (with motorised lock)	57	9 Glossary	75
Controller and expansion	36	In-Home bus – 1 Door station (tamper-proof), Call via COM	58	10 Symbols used and their meaning	77
Power supply	37	7.2 Installation SC 600-...	60	11 After-sales service	78
Programming – EC 602-...	38	Basic circuit diagram SC 600-... – 4 Door stations	60		
Space requirement in the distributor	38	SC 600-... + 2 SE 600-... – Secure Extension as an extension for the Secure Controller	62		
7 Installation	39	Access Professional – 1 Door station	63		
General information	39				
Basic circuit diagram, stand-alone operation with ELM 600/611-... and DSC 602-...	40				
Basic circuit diagram, stand-alone operation with FPM 600-... and DSC 602-...	41				

Remarks

This document serves as a guide for the planning and technical implementation of a Siedle access control system.

It is designed to provide an overview of the key points that need to be observed.

This document supplements and is supplemented by the system manuals for the following Siedle door communication systems: Siedle In-Home bus, Siedle Access Professional and Siedle 1+n technology. The latest version can be found in the Downloads section at www.siedle.com

Qualified contacts are on hand to offer a fast, professional service. By telephone, or if required we will be pleased to visit you on site. (For detailed information, see page 78)

We accept no liability for modifications, mistakes or printing errors.

Modifications / additions, mistakes or printing errors do not form grounds for any claim to compensation for damages.

1 Planning help

Access control requirements vary depending on the type and function of the building.

This planning help is designed to help you quickly identify the right system for you.

Please note that the planning help only provides a recommendation.

Find the right access control in just four steps:

1. What are my access control requirements?

2. Which expansion stage is right for me?

3. Which input/read unit(s) do I want to use?

4. Which configuration (expansion stage + input/read unit) makes sense for me?

1. What are my requirements?

Number of users?	<input type="checkbox"/> 1–9
	<input type="checkbox"/> 10–99
	<input type="checkbox"/> 100–499
	<input type="checkbox"/> > 500

Number of doors to be controlled?	<input type="checkbox"/> 1
	<input type="checkbox"/> 2–8
	<input type="checkbox"/> > 8

Stand-alone or networked operation? (see description below)	<input type="checkbox"/> Stand alone operation
	<input type="checkbox"/> Networked operation

Stand alone operation

During stand-alone operation, each input/read device is operated alone.

Characteristics:

- The switching contact for opening the door is located directly in the input/read unit. A pilfer safeguard is recommended.
- Users must be separately taught-in at each input/read unit.
- User actions cannot be logged.

Networked operation

During networked operation, the input/read devices of the different access points are linked to one another via a central device (controller).

Characteristics:

- The switching contact for opening the door is located in the controller.
- Users can be created and maintained centrally; depending on the version, this can be carried out with ease via a web interface.
- Depending on the version, user actions can be logged.
- Control of several input/read units via one controller, a combination of different input/read units possible.
- Depending on the version, time profiles can be created.

1 Planning help

2. Which expansion stage is right for me? (pre-selection)

		Number of users			
		1-9	10-99	100-499	> 500
Number of doors to be controlled	1	A / B	A / B	C	D
	2-8	A / B	B	C	D
	> 8	D	D	D	D

The selection of the expansion stage is a pre-selection. After selecting the input/read unit(s) that you want to use, you can use this preselection to help determine the system that makes the most sense for your application. See page 8.

3. Which input/read unit(s) do I want to use?



The following input/read units are currently available for selection:

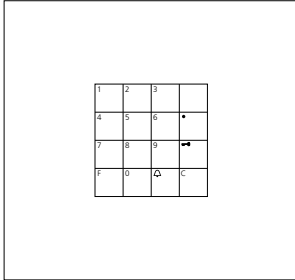

COM 611-02

In the case of the code lock module, the door release is triggered by entering a key code.

Factors and advantages:

- Depending on the expansion stage, up to 99 or up to 500,000 key codes can be configured
- Easy, convenient handling
- No need for keys
- Well suited for the private use
- Well suited to access control for server rooms, etc.

Drawbacks:

- Key code can be read by third parties when being entered

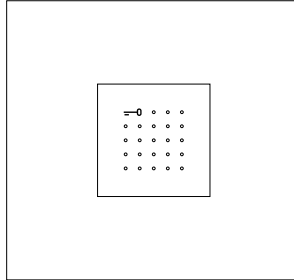

ELM 600-0

The electronic key reading module is the read unit for access control via RFID card or RFID tag (electronic key).

Factors and advantages:

- Depending on the expansion stage, up to 9/899/500,000 cards or electronic keys can be read in
- Easy, convenient handling
- If lost, the cards or electronic keys can be deleted. The door's locking cylinder does not need to be replaced.
- Well suited to access control for offices, etc.

Drawbacks:

- If lost, third parties can gain access to the building, etc. using the card/electronic key. (However, the SC 600-... Secure Controller enables a combination of card/key and PIN code to prevent this.)
- Card/electronic key must be carried

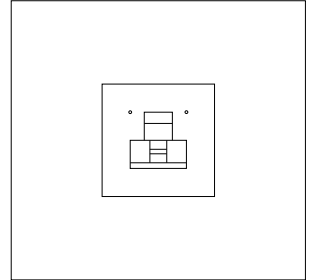

FPM 600-0

The fingerprint module is based on biometrics: The user's fingerprint is read and this opens the door.

Factors and advantages:



- Up to 100 user fingerprints can be read in
- Easy, convenient handling
- No need for keys
- Unique factor which can only be copied with great effort
- Well suited for the private use
- Well suited to access control for rooms with restricted access, etc.

Drawbacks:

- Not suitable for small children (fingerprint not yet fully developed)
- Injured fingers may not be recognised
- Only stand-alone and therefore cannot be used for EC 602-... or SC 600-....
- Data backup not possible.

1 Planning help

4. Which configuration (expansion stage + input/read unit) makes sense for me?
(recommendation)

	Upgrade stage			
	A	B	C	D
Operating mode	Stand alone operation	Operation with entrance controller EC 602-...	Operation with Secure Controller SC 600-...	Networking several Secure Controller SC 600-...
Predominating building type	Detached home, individual rooms (e.g. server room), storey doors, e.g. in apartment buildings	Detached home/apartment building	Commercial building	Industrial building
 PIN code	No *	Yes	Yes	Yes
 Fingerprint	Yes	No	No	No
 RFID card / RFID tag (electronic key)	Yes	Yes	Yes	Yes
System example(s)	<ul style="list-style-type: none"> • Detached home with FPM** see page 10 • Access to individual offices with ELM see page 16 	<ul style="list-style-type: none"> • Detached home with COM see page 12 • Apartment building with COM see page 14 • Industrial building with ELM see page 18 	<ul style="list-style-type: none"> • Industrial building with ELM see page 20 	<ul style="list-style-type: none"> • Industrial buildings at several locations, with ELM see page 22

* PIN code (COM) not possible in stand-alone operation.

** A maximum of 100 user fingerprints can be read in on the FPM.

Upgrade stage A

= Stand alone operation

Characteristics:

- 1 access point is controlled.
- With FPM 600-... up to 100 users
- With ELM up to 9 users
- The master is needed to create new users.
- It is not possible to delete individual users.

Upgrade stage B

= Operation with entrance controller EC 602-...

Characteristics:

- Up to 8 access points can be controlled with the fully extended system
- With COM up to 99 users
- With ELM up to 999 users (can be set via PC software)
- Different input/read units can be combined (at the same door or at different doors)
- New users can be created manually via EC or via PC software.
- Individual users can be deleted.

Upgrade stage C

= Operation with Secure Controller SC 600-...

Characteristics:

- Up to 4 access points can be controlled with the fully extended system
- Up to 500.000 users.
- Different input/read units can be combined (at the same door or at different doors)
- New users can be created via administration interface.
- Individual users can be deleted.
- User actions are logged.
- Different time profiles can be configured.

Upgrade stage D

= Networking several SC 600-... Secure Controllers and/or use of SE 600-... Secure Extension.

Characteristics:

- Number of access points can be scaled via the networked door controller
- Over 500.000 users (depending on the capacity of the network)
- New users can be created via administration interface.
- Individual users can be deleted.
- User actions are logged.
- Different time profiles can be configured.

2 Configuration examples

Detached house with fingerprint module (FPM)

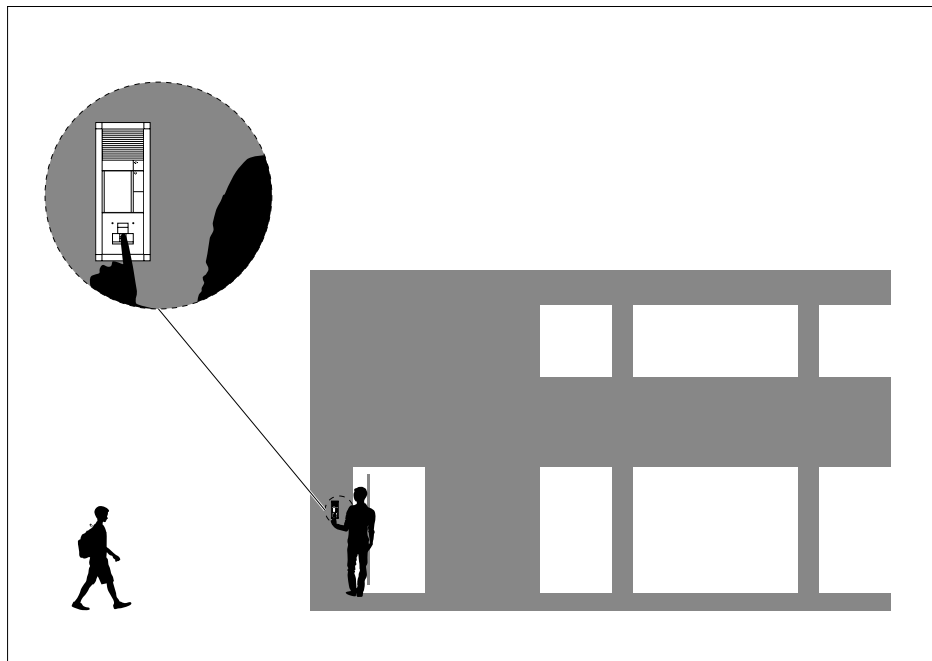

Starting situation

- Detached family home, Family with 1 child (3 users)
- 1 Access
- Keyless access required (no RFID card/RFID tag)

Recommended access control

- Stand alone operation
- Input unit FPM

Remarks

- To prevent burglaries, we recommend the use of a motorised lock according to current guidance (resistance class RC 2) instead of a door release.
- A potential-free contact is available for controlling a customer-provided motorised lock.
- If a standard door release is to be used, use a 12 V AC door release with an impedance of min. 20 Ohm (e.g. TÖ 615-...).
- Fingerprint modules work on the basis of biometrics and recognise individual fingerprints. This fingerprint pattern does not fully develop until around six years of age. Therefore fingerprint recognition is not suitable for small children.
- When using an FPM 600-..., we recommend reading in two user

fingerprints per user. Should, for example, one finger be injured, the user can still trigger the door release with the other finger.

You can find further information about the individual products in the detailed function overview. See page 24.

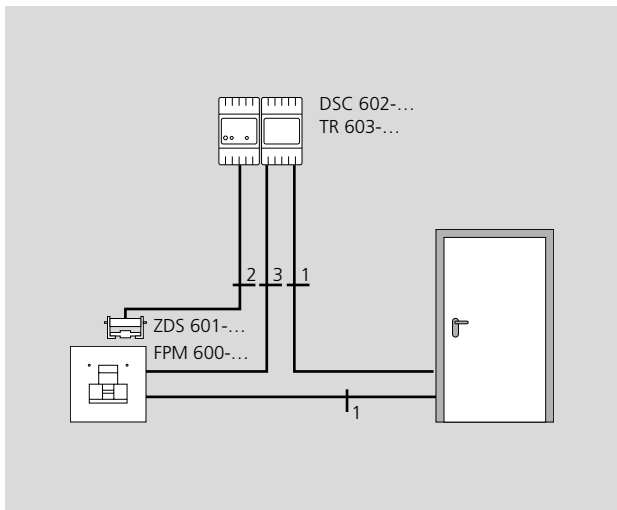
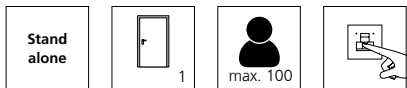

Recommendation – Pilfer safeguard

In stand-alone operation, the switching contact for opening the door is located in the device. If the read unit is in an unprotected outdoor area or a publicly accessible area, we recommend using a pilfer safeguard (DSC 602-... + ZDS 601-...) to protect against unauthorised intrusion.

Components required

- 1x Fingerprint module FPM 600-...
- 1x Transformer TR 603-...
- 1x Motorised lock or Door release 12 V AC, with at least 20 Ohm (e.g. TÖ 615-...)

Wiring diagram

see page 41

Additional pilfer safeguard components

- 1x Anti-pilfer controller DSC 602-...
- 1x Anti-pilfer accessory ZDS 601-...

2 Configuration examples

Detached house with code lock module (COM)

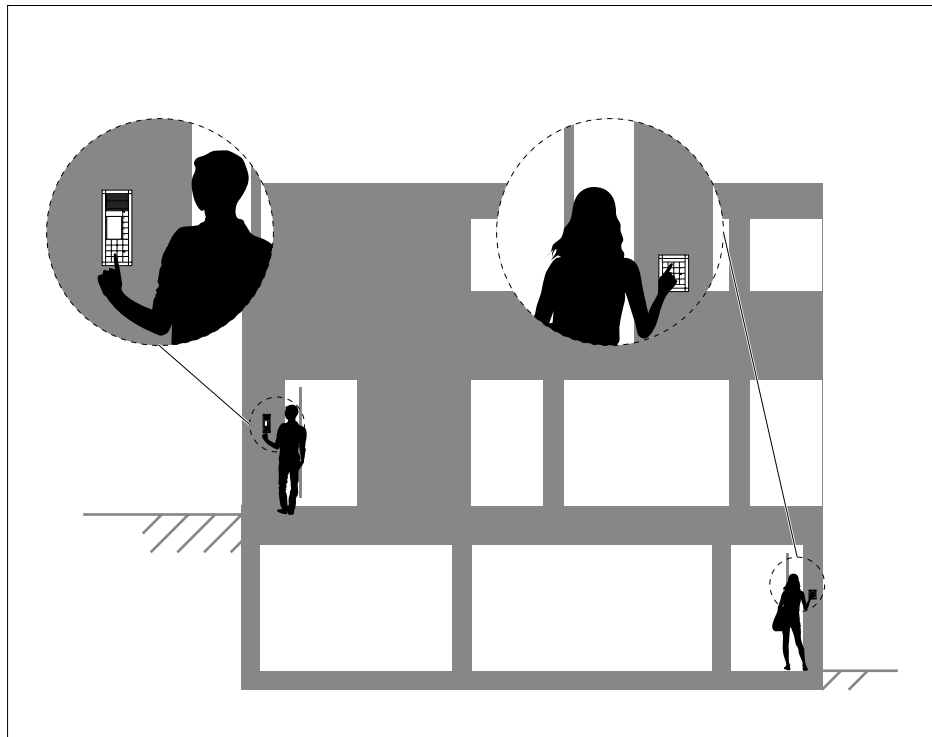

Starting situation

- Detached family home, Family with 2 children
- 2 access points: 1 front door, 1 access point to garage/cellar/etc.
- Keyless access required (no RFID card/RFID tag)

Recommended access control

- Vario bus operation with EC
- Input unit COM

Remarks

- To prevent burglaries, we recommend the use of a motorised lock according to current guidance (resistance class RC 2) instead of a door release.

A potential-free contact is available for controlling a customer-provided motorised lock.

- If a standard door release is to be used, use a 12 V AC door release with an impedance of min. 20 Ohm (e.g. TÖ 615-...).
- Depending on the usage frequency, frequently used numbers may stand out visually against less frequently used numbers. Therefore, we recommend assigning each user their own code and changing the codes at regular intervals.

You can find further information about the individual products in the detailed function overview. See page 24.



EC



2



max. 99

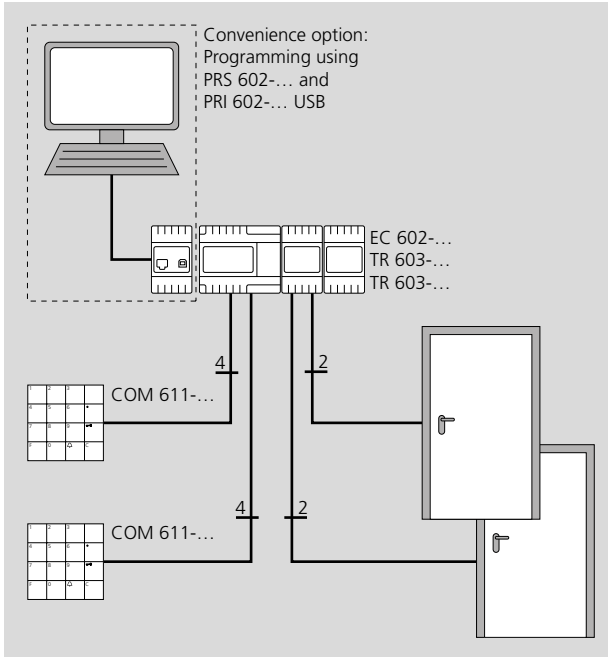

Further input/read units possible on the same door

The EC 602-... entrance controller allows several input/read units to be combined on one door station (e.g. COM).

If more than 2 door stations are to be managed (up to 8), the ECE 602-... entrance controller extension is also required.

Components required

2x	Code lock module COM 611-...
1x	Entrance controller EC 602-...
2x	Transformer TR 603-...
2x	Motorised lock or Door release 12 V AC, with at least 20 Ohm (e.g. TÖ 615-...)

Terminal plans

See page onwards 42

Note

When using motorised locks an ECE 602-... entrance controller extension is needed as of the 2nd door.

2 Configuration examples

Apartment block with code lock module (COM)

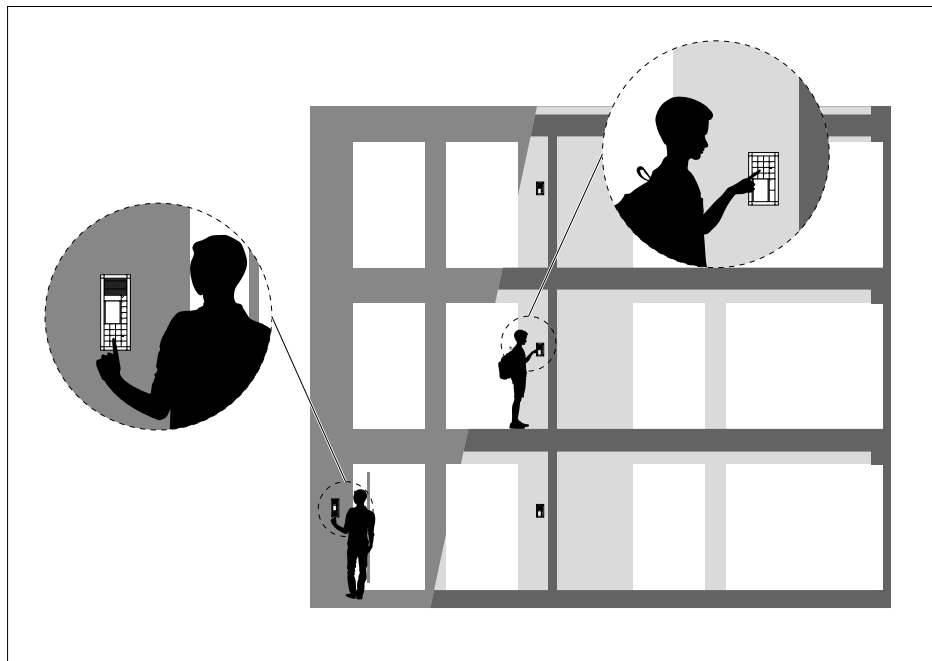

Starting situation

- Multiple family home, 3 tenants (e.g. multi-generation house)
- Residents of all ages, if required more than 9 residents
- 4 Access points: 1 front door, 3 storey doors
- Keyless access desired/identification via key code
- Networked operation of input/read units: All residents need to be able to open the front door using a code

Recommended access control

- Vario bus operation with EC
- Input unit COM

Remarks

- To prevent burglaries, we recommend the use of a motorised lock according to current guidance (resistance class RC 2) instead of a door release. A potential-free contact is available for controlling a customer-provided motorised lock.
- If a standard door release is to be used, use a 12 V AC door release with an impedance of min. 20 Ohm (e.g. TÖ 615-...).

You can find further information about the individual products in the detailed function overview. See page 24.

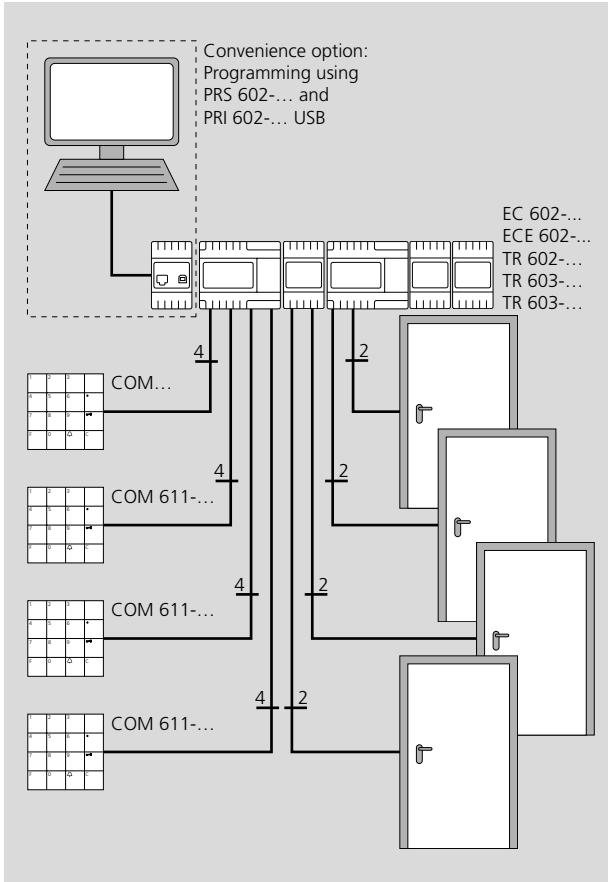

Further input/read units possible on the same door

The EC 602-... entrance controller allows several input/read units to be combined on one door station (e.g. COM).

The EC 602-... can (with the ECE 602-...) manage up to 8 doors, i.e. a total of up to 8 COM 611-..., 8 ELM... and 8 DRM 611-..., at the same time.

Components required

- 4x Code lock module COM 611-...
- 1x Entrance controller EC 602-...
- 1x Eingangs-Controller-Erweiterung ECE 602-...
- 1x Transformer TR 602-...
- 2x Transformer TR 603-...
- 4x Motorised lock or Door release 12 V AC, with at least 20 Ohm (e.g. TÖ 615-...)

Terminal plans

See page onwards 47

2 Configuration examples

Commercial building/access to individual offices with electronic key reading module (ELM)

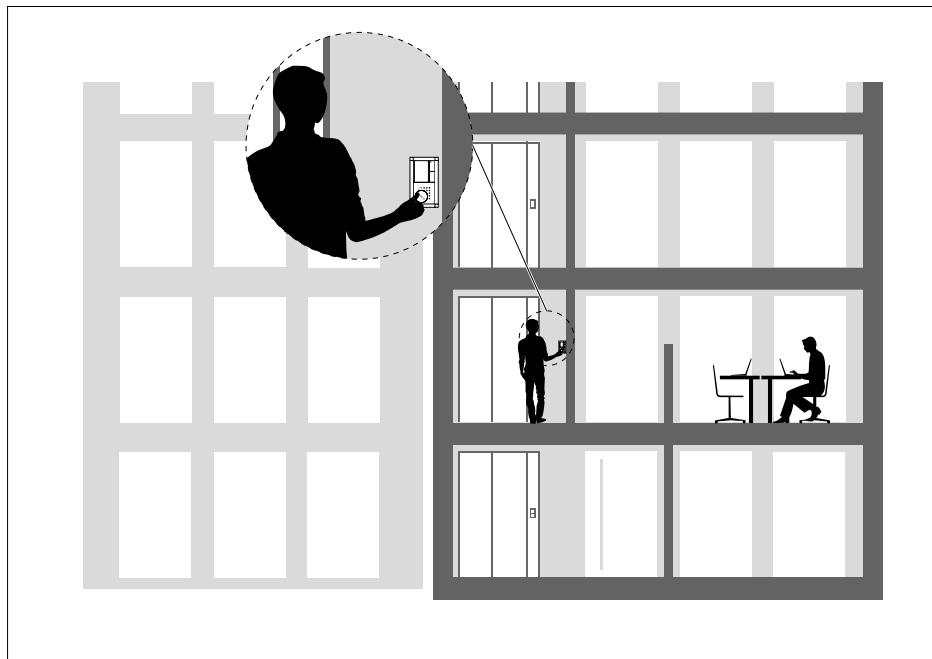

Starting situation

- Small company with up to 9 employees
- 1 Access: Storey door in a commercial building
- Identification via RFID card/RFID tag desired

Recommended access control

- Stand alone operation
- Input unit ELM

Remarks

- To prevent burglaries, we recommend the use of a motorised lock according to current guidance (resistance class RC 2) instead of a door release. A potential-free contact is available for controlling a customer-provided motorised lock.
- If a standard door release is to be used, use a 12 V AC door release with an impedance of min. 20 Ohm (e.g. TÖ 615-...).

You can find further information about the individual products in the detailed function overview. See page 24.

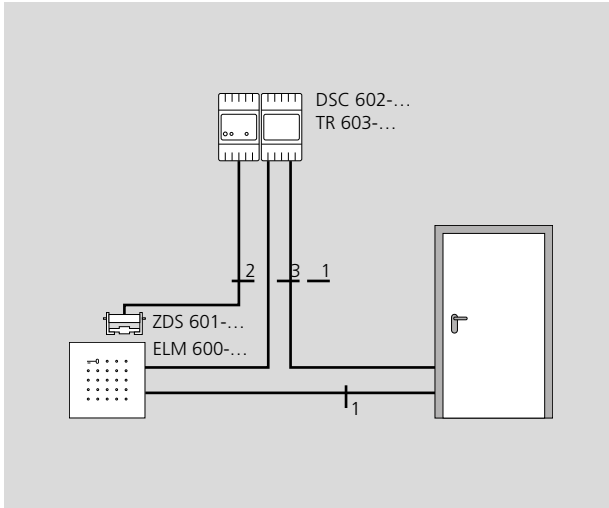

Recommendation – Pilfer safeguard

In stand-alone operation, the switching contact for opening the door is located in the device. If the read unit is in an unprotected outdoor area or a publicly accessible area, we recommend using a pilfer safeguard (DSC 602-... + ZDS 601-...) to protect against unauthorised intrusion.

Components required

1x	Electronic-key reading module ELM...
1x	Transformer TR 603-...
1x	Motorised lock or Door release 12 V AC, with at least 20 Ohm (e.g. TÖ 615-...)
Required number of EKC 600-... electronic key cards and/or EK 600-... electronic keys (number of users + 1 master card)	

Additional pilfer safeguard components

1x	Anti-pilfer controller DSC 602-...
1x	Anti-pilfer accessory ZDS 601-...

Wiring diagram

See page onwards 40

2 Configuration examples

Industrial buildings with electronic key reading module (ELM)

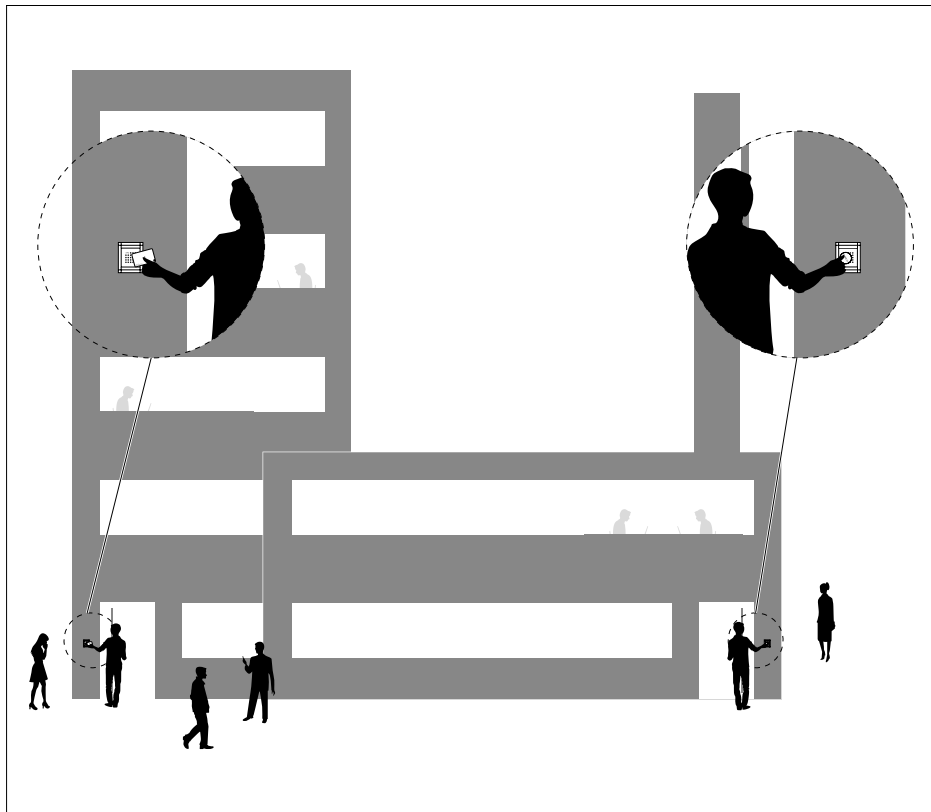

Starting situation

- Industrial building with up to 500 employees
- 2 Access points
- Identification via RFID cards/RFID tags or PIN code
- Any employee can access the building at any time/time profiles are not required for individual users
- No user management needed

Recommended access control

- Vario bus operation with EC
- Input unit ELM

Remarks

- To prevent burglaries, we recommend the use of a motorised lock according to current guidance (resistance class RC 2) instead of a door release.
A potential-free contact is available for controlling a customer-provided motorised lock.
 - If a standard door release is to be used, use a 12 V AC door release with an impedance of min. 20 Ohm (e.g. TÖ 615-...).
 - Cards or codes can be managed via the entrance controller (manually or via PC).
- The configuration is normally carried out by an electrician.

You can find further information about the individual products in the detailed function overview. See page 24.

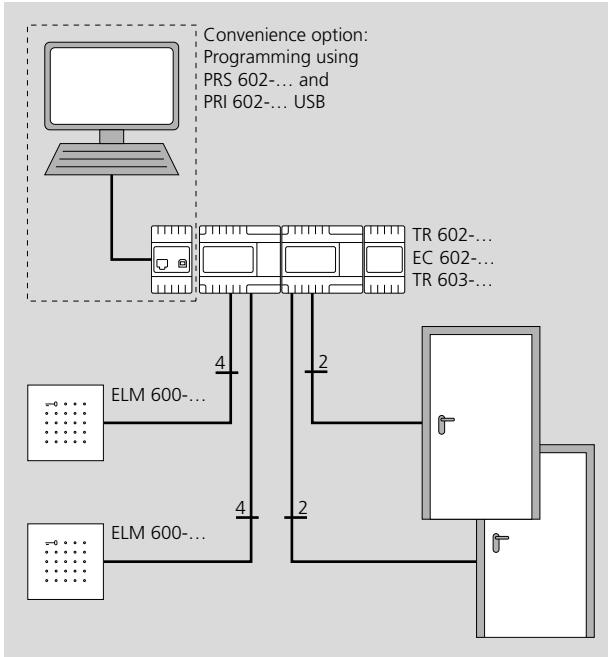

Further input/read units possible on the same door

The EC 602 allows several input/read units to be combined on one door station (e.g. COM).

If more than 2 door stations are to be managed (up to 8), the ECE 602-... entrance controller extension is also required.

Components required

2x	Electronic-key reading module ELM 600-...
1x	Transformer TR 602-...
1x	Transformer TR 603-...
2x	Motorised lock or Door release 12 V AC, with at least 20 Ohm (e.g. TÖ 615-...)
1x	Entrance controller EC 602-...

Required number of EKC 600-... electronic key cards and/or EK 600-... electronic keys (number of users)

Note

When using motorised locks an ECE 602-... entrance controller extension is needed as of the 2nd door.

Wiring diagram

See page onwards 46

2 Configuration examples

Industrial buildings with electronic key reading module (ELM)

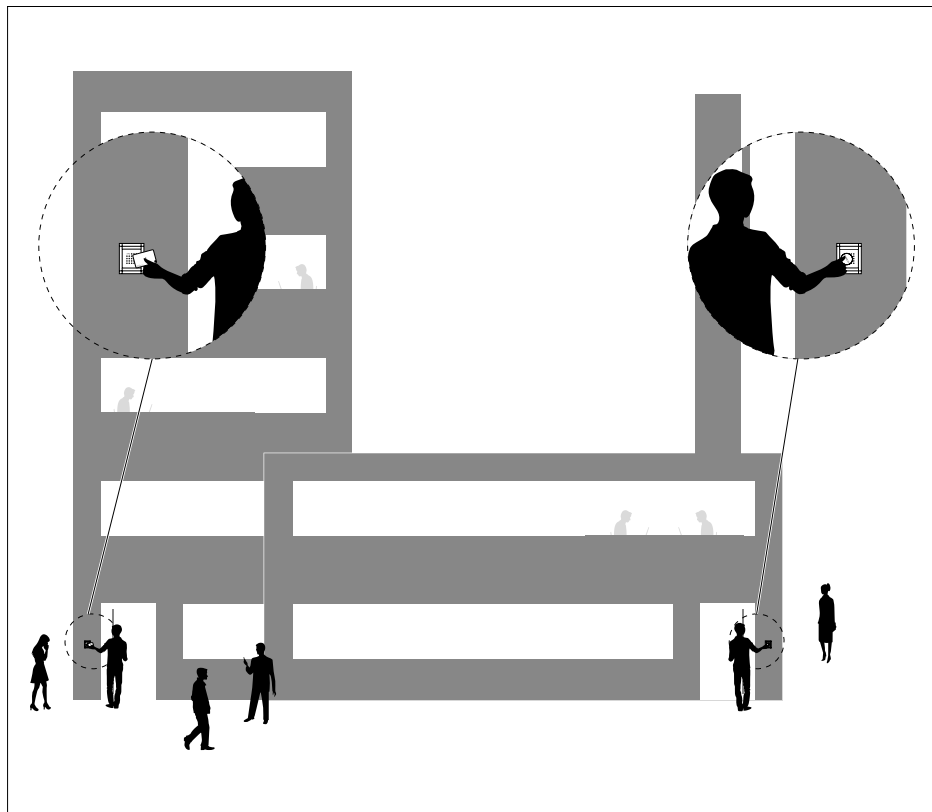

Starting situation

- Industrial building with up to 500 employees
- 2 Access points
- Identification via RFID cards/RFID tags or PIN code
- Access only possible at specific times/time profiles required for the users
- User management via web interface

Recommended access control

- Vario bus operation with SC 600-...
- Input unit ELM

Remarks

- To prevent burglaries, we recommend the use of a motorised lock according to current guidance (resistance class RC 2) instead of a door release.
- A potential-free contact is available for controlling a customer-provided motorised lock.
- If a standard door release is to be used, use a 12 V AC door release with an impedance of min. 20 Ohm (e.g. TÖ 615-...).
 - Access and time profiles for the users can be defined at any time via the administration interface.

You can find further information about the individual products in the detailed function overview. See page 24.

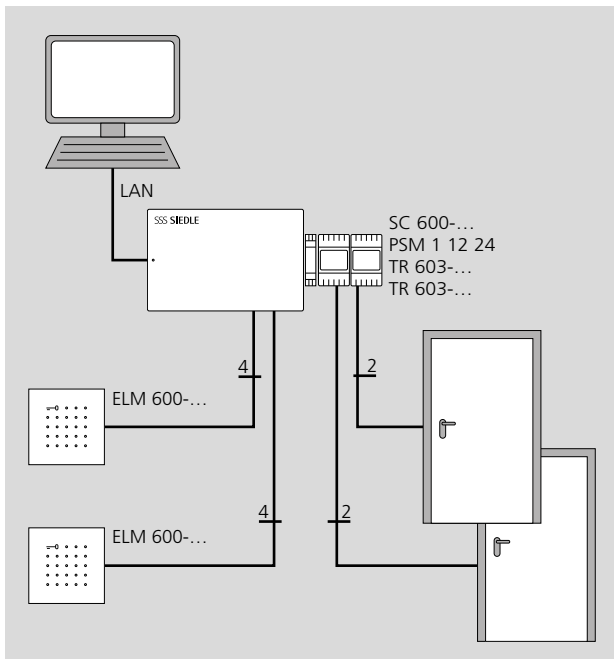
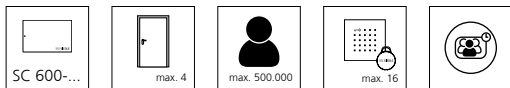

Further input/read units possible on the same door

The SC 600 Secure Controller allows several input/read units to be combined on one door station (e.g. COM).

When operated with the Siedle Vario bus protocol, up to 8 read/input units of the same type can be operated per RS485 interface (max. 16 read/input units: 8 x ELM... + 8 x COM... per RS485 interface = 32 read/input units per controller). The following read/input units are permitted for operation of the access control system with read/input units from Siedle: ELM 600-..., COM 611-..., SC 600-... More than 4 door stations can be managed with several networked SC 600-... or with the aid of additional SE 600-...

Components required

1x	Secure Controller SC 600-...
1x	Line rectifier PSM 1 12 24 (for SC 600-... not essential, as PoE supply also possible)
2x	Transformer TR 603-...
2x	Motorised lock or Door release 12 V AC, with at least 20 Ohm (e.g. TÖ 615-...)
Required number of EKC 600-... electronic key cards and/or EK 600-... electronic keys (number of users)	

Wiring diagram

See page onwards 60

2 Configuration examples

Industrial buildings at several locations, with electronic key reading module (ELM)

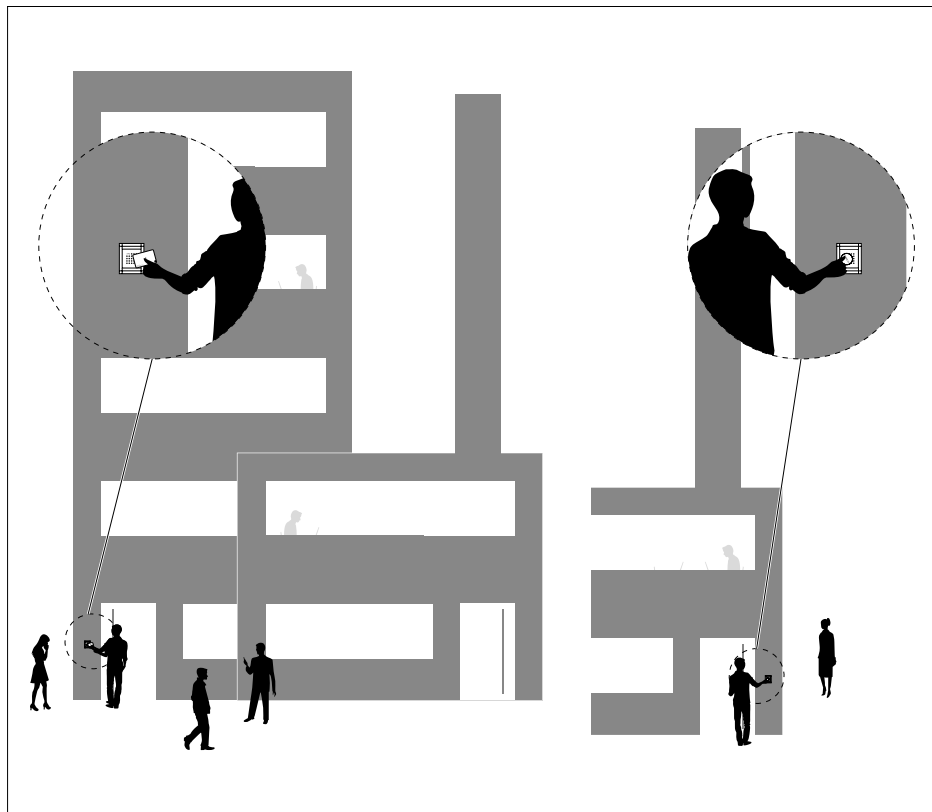

Starting situation

- Industrial building with 500 employees or more, distributed across 2 locations
- Location A: 2 buildings with a total of 4 access points
- Location B: 1 building with a total of 2 access points
- Identification via RFID card/RFID tag desired
- User management via web interface
- Networked operation of the locations required (central management of all users)

Recommended access control

- Vario bus operation with ELM 600-...
- Input unit ELM 600-...

Remarks

- To prevent burglaries, we recommend the use of a motorised lock according to current guidance (resistance class RC 2) instead of a door release. A potential-free contact is available for controlling a customer-provided motorised lock.
- If a standard door release is to be used, use a 12 V AC door release with an impedance of min. 20 Ohm (e.g. TÖ 615-...).
- Access and time profiles for the users can be defined at any time via the administration interface.

You can find further information about the individual products in the detailed function overview. See page 24.

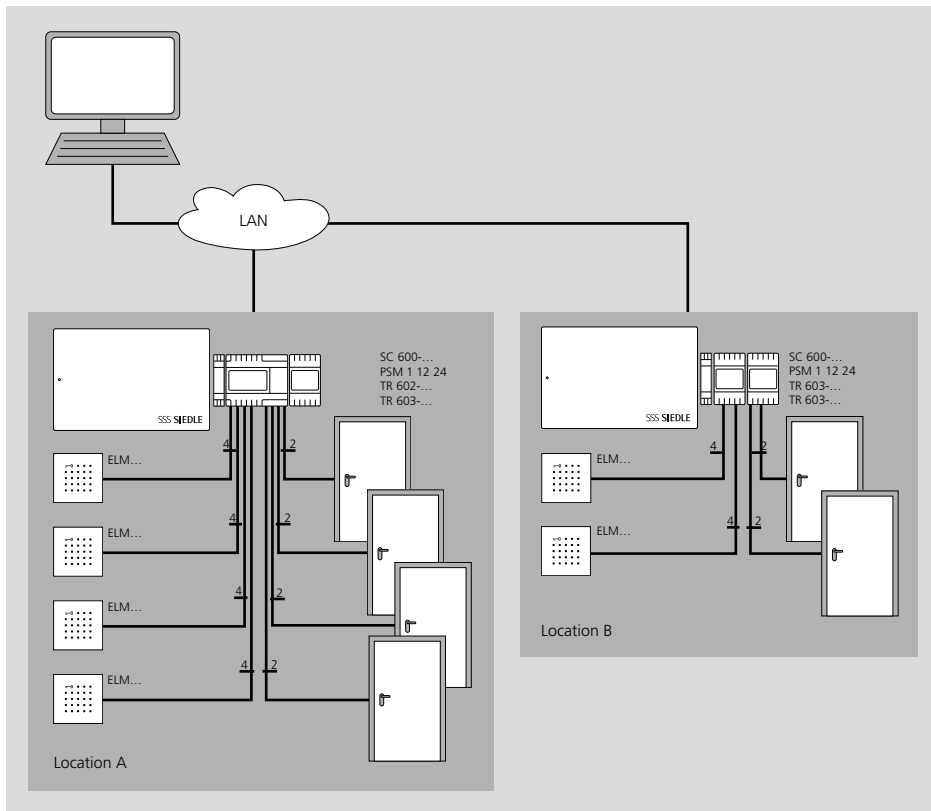
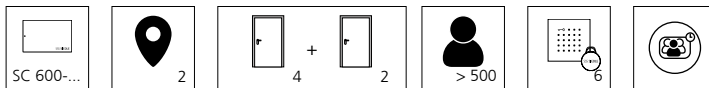

Components required

- 2x Secure Controller SC 600-...
- 2x Line rectifier PSM 1 12 24 (for SC 600-... not essential, as PoE supply also possible)
- 1x Transformer TR 602-...
- 3x Transformer TR 603-...
- 6x Electronic-key reading module ELM...
- 6x Motorised lock or Door release 12 V AC, with at least 20 Ohm (e.g. TÖ 615-...)









Required number of EKC 600-... electronic key cards and/or EK 600-... electronic keys (number of users)

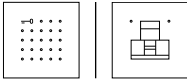





Terminal plans

see page 60 and 63

3 Function overview

Detailed overview of the expansion stages

Component/ property	 Stand alone operation	 EC 602-...	 + ECE 602-...
	1	max. 2	+ 6 (max. 8)
	✓	✓ (max. 8 ELM)	
	–	✓ (max. 8 COM) Max. 99 codes can be programmed	
	Number of users depends on the authentication factor	Number of users depends on the authentication factor	
	–	With input block 2 time profiles are possible ("Around the clock access" and via access times controlled by a timer)	
	–	max. 2 Gateways	+ 2 Gateways (max. 4 time-controlled gateways)
Networking	–	–	–
Number of switching contacts	1 Switching contact (directly on the ELM)	2 Switching contacts	+ 6 Switching contacts
Number of switching inputs	–	2 Switching inputs	
Number of input/read units	1	Max. 8 per device type	
Individual, stored factors can be deleted	–	✓	
Programming	manually	manual or via PC (PC connection via programming interface)	
Several input/read units can be combined	–	✓	

Component/property	SC 600-...	SC 600-... + 1 SE 600-...	SC 600-... + 2 SE 600-...
	max. 4 Doors (Access points)	max. 8 Doors (Access points)	max. 12 Doors (Access points)
	✓ (max. 16 ELM)	✓ (max. 8 ELM)	✓ (max. 8 ELM)
	✓ (max. 16 COM)	✓ (max. 8 COM)	✓ (max. 8 COM)
	(Up to 500.000 users)	(Up to 500.000 users)	(Up to 500.000 users)
	✓ (Access groups and time profiles/week programmes)	✓ (Access groups and time profiles/week programmes)	✓ (Access groups and time profiles/week programmes)
	✓ max. 2 Gateways	✓ max. 4 Gateways	✓ max. 6 Gateways
Networking	max. 64 SC 600-...	max. 64 SC 600-...	max. 64 SC 600-...
Number of switching contacts	4 Switching contacts 3 Control outputs	8 Switching contacts 3 Control outputs	12 Switching contacts 3 Control outputs
Number of switching inputs	8 Switching inputs	16 Switching inputs	24 Switching inputs
Number of input/ read units	max. 16	max. 8	max. 8
Individual, stored factors can be deleted	✓	✓	✓
Programming	Via administration interface	Via administration interface	Via administration interface
Several input/read units can be combined	✓	✓	✓

3 Function overview

Detailed overview of the expansion stages

Door planning overview

SC 600-.../SE 600-...

Anzahl: Doors*	ELM	SC 600-...	SE 600-...	PSM 1 12 24	TR 602-...
4	4	1	–	1	1
8	8	1	1	1	2
12	12	2	1	2	3
16	16	2	2	2	4

*1 door = 1 x ELM + 1 x motorised lock or door release 12 V AC (e.g. TÖ 615-...)

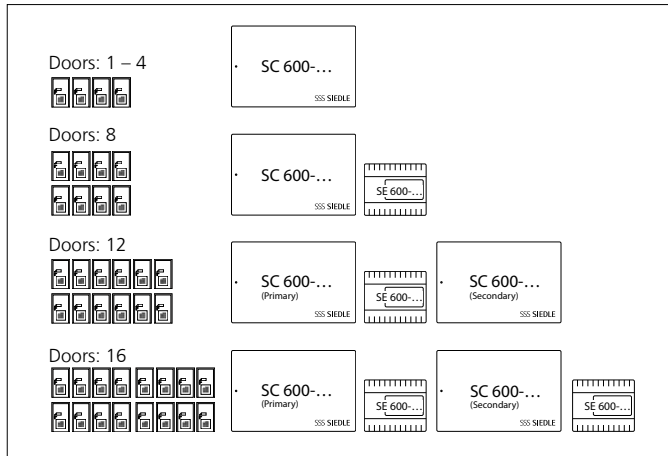

Information about components and properties

Electronic-key reading module ELM 600-...

ELM can be used for both stand-alone operation or with a controller (EC 602-... or SC 600-...).

ELM are only functional when installed.

For ELM in the Siedle Vario design line this means, for example, that they must be snapped into the MR 611-...mounting frame.

The ELM 600-... offers increased security via MIFARE DESFire EV2 compared to the ELM 611-... The ELM 600-... can only be used in conjunction with the EKC 600-... cards and the EK 600-... keys.

Fingerprint module FPM 600-...

FPM can be used for stand-alone operation.

When using an FPM 600-..., we recommend reading in two user fingerprints per user. Should, for example, one finger be injured, the user can still trigger the door release with the other finger.

A maximum of 100 user fingerprints can be read into a system. As the data is directly stored in the FPM 600-..., this number cannot be increased by using several FPM 600-...

Code lock module COM 611-...

The COM 611-... can only be used in conjunction with a controller. Stand-alone operation is not possible.

The COM 611-... can be used for access control and/or digital call input.

Gateway/cascade control for 2 door releases

The door release contacts are triggered one after the other within a configured time. I.e after the factor has been read in or entered (card/code), the first door release contact is triggered and then – after a pre-determined time – the second door contact is triggered.

For operation in both directions, 2 gateways and associated read/input units are needed.

Time profiles/weekly programmes

The time profile/week programme determines the times and days when a user or a user group is granted access. Start and end times per weekday/public holiday and a number of different optional access conditions can be specified for each time profile/week programme. Several start/end times can be assigned to each day. A time profile/week programme can also be configured for an individual door and a hierarchy can be defined for the various time profiles.

Device configuration (guided commissioning)

(only for operation with SC 600-...)

The Secure Controller's commissioning wizard offers guided commissioning for configuring the access points and read/input units attached to the access control system.

4 Safety remarks



Mounting, installation and servicing work on electrical devices may only be performed by a suitably qualified electrician. Failure to observe this regulation could result in the risk of serious damage to health or fatal injury due to electric shocks.

- When working at the device, observe the remarks relating to mains cut-off.
- Observe the DIN EN 60065 standard! When establishing the electronic connection, observe the requirements of VDE 0805 or EN 60950.
- The building installation must include an all-pole mains switch with a contact separation of at least 3 mm.
- Ensure maximum fusing of 16 A for the mains connection in the building installation.
- When planning large-scale (complex) systems, the distributor space required for the switch panel mounting devices must be taken into consideration in the distributor planning process.
- No external voltages >30 V AC/DC may be applied to the devices.

Devices with 230 V connection

In accordance with DIN VDE 0100 part 410, section 411.1.3 attention must be paid to ensuring a safe separation between system lines and the mains voltage; i.e. system and mains cores must not be permitted to touch! The system line cable (extra-low safety voltage) must be stripped back by the minimum possible.

Burglary protection

Standard 12 V AC door releases are not regarded as a locked door by insurance companies. In the event of a burglary, damage is not generally covered.

Therefore, we recommend using a motorised lock according to current guidelines (resistance class RC 2).

Electrical distribution boards and IT cabinet systems

Please make sufficient provisions in the electrical distribution boards/IT cabinet system for later expansion, changes or subsequent disassembly (service/maintenance).

Plan the electrical distribution board/ the IT cabinet system so that the heat generated by all installed components is adequately dissipated and cannot impair any functions or cause damage to the components or infrastructure at the installation site.

During planning, take the applicable legal provisions, standards, directives and safety instructions for the operation/installation site into account.

All system components which are designed for/suitable for installation in an electrical distribution board or in an IT cabinet system/housing may only be installed in the permitted installation position according to the enclosed product information.

If system components are operated in improper installation positions or with improper operating parameters (e.g. excessive ambient temperature), this will render their warranty rights void in the event of service.

Protect your network!

Only use up-to-date components and terminals in the network in line with the latest state of the art. Regularly update the operating systems of all components and terminals. Exchange obsolete components and terminals for up-to-date models. Use professional protective software (antivirus, firewall, ...) in all terminals. Issue secure passwords.

Secure your network with the highest security standards available in the network. Protect your network against unauthorized attack from inside and outside.

Safety remark!

All data connections to an SC 600-... are unencrypted. If there are increased security requirements here, the connection should be established via a VPN tunnel.

Legal notice

The fingerprint module digitalises the users' fingerprints and stores them for identification purposes. The fingerprint data is not stored as a graphic, but as a hash code (character string) in the fingerprint module.

It is not possible to create a real image of a fingerprint from a hash code.

The users' consent must be obtained to use digital fingerprints and evaluate user data (e.g. logging of access and system data or attendance/absentee list).

Legal, legitimate operation of Siedle access control and the associated system components (hardware and software) are always the responsibility of the operator and not the device manufacturer.

5 Establishing access control with Vario bus

Installation notes

The Vario bus is the bus system for Siedle access control and connects its system components to one another.

In addition, "digital calls" can be added to a door communication system with the Vario bus.

The basic installation of the Vario bus is carried out using a four-core Vario bus line (two core pairs).

One core pair (bv, cv) forms the supply line and supplies the power to the devices. Another core pair (Da, Db) forms the data line and enables data transfer and transfer of switching and control signals.

Nodes and branches are permitted at any point on the Vario bus line, taking into account the permissible ranges.

Telecommunication cables must be used for installation.

J-Y(St)Y	Twisted pair conductors, shielded
A-2Y(St)2Y	Buried telecommunication cable

For new installations, we recommend using standard available conductor material J-Y(St)Y with 0.8 mm core diameter.

Conductor routing

In order to comply with the general safety regulations for telecommunication systems according to VDE 0100 and VDE 0800, and to avoid interference, ensure that the heavy and light current conductors are separately routed, observing a distance of 10 cm. See also the relevant national and local regulations.

5 Establishing access control with Vario bus

Power supply

The Vario bus system components can be supplied with the following power supply:

Models /Power supply	TR 602-... (12 V AC) *	TR 603-... (12 V AC) *	PSM 1 12 24 24 V DC	PoE (Power over Ethernet)
Input/read unit				
ELM 600-...	✓	✓		
COM 611-...	✓	✓		
Controller				
EC 602-...	✓	✓		
SC 600-...			✓	✓
Controller extension				
ECE 602-...	Supply via EC 602-...			
SE 600-...	Supply via SC 600-... (max. 2)**			

* Steps must be taken to ensure that the supply voltage never falls below 9 V AC at any time at maximum current input to each device.

** If more than two SE 600-...are used, these must be directly supplied via a PSM 1 12 24.

Range

The maximum range of the Vario bus varies between the supply line and data line.

Supply line range

The supply line's loop resistance (go and return line between input/read unit and power supply) must not exceed 20 Ohm.

In the case of communication lines with a core diameter of 0.8 mm, this results in a maximum technically-determined range of approx. 260 m. The range that can be achieved depends on the current consumption of the devices to be supplied and the type of installation (star/bus installation).

To facilitate calculation, the current consumption for the modules is given in "AW" connected load values.

Connected load values	AW
COM 611-...	1
ELM 600-...	1
ELM 611-...	1
EC 602-...	1
EC 602-... + ECE 602-...	2

One TR 603-... supplies 2 AWs

One TR 602-... supplies 5 AWs

If the same power supply supplies both the controller and the input/read units, the controller has no effect on the range calculation for the input/read units, provided it is located directly by the power supply.

Star-shaped installation

In the case of the star-shaped installation, each input/read unit is supplied by a separate line.

The range between the transformer and input/read units in the case of a star-shaped installation is max. 260 m with a core diameter of 0.8 mm and a connected load value "1 AW". An additional input/read unit in the same line with a connected load value of 1 AW reduces the range for 2 AW (1 AW + 1 AW = 2 AW) to 130 m.

Bus installation

In the case of bus installation, several input/read units are supplied via a common supply line.

Up to 5 AW can be operated with a core diameter of 0.8 mm via one supply line and power supply.

Additional devices will need their own, completely separate supply line and power supply.

AW	Range
1	260 m
2	130 m
3	75 m
4	50 m
5	40 m

All specifications relating to ranges refer to the above mentioned conductor material with 0.8 mm core diameter.

With a core diameter of 0.6 mm, the range is halved.

Steps must be taken to ensure that the supply voltage never falls below 9 V AC at any time at maximum current input to each device.

Data line range

Each controller (EC 602-... / SC 600-...) provides the connection for the data line of the read/ input units in the Vario bus and must be operated alone as an independent Vario bus line.

The entire length of the data line within a Vario bus line between input/read units and the associated controller is max. 2000 m.

Nodes and branches are permitted at any point on the Vario bus line, taking into account the permissible ranges.

With a core diameter of 0.6 mm, the range is halved.

Up to 8 Vario bus addresses are available per device.

Each Vario bus address may be assigned once per device type (ELM 600/611-... / COM 612-...).

This means that up to 8 devices of the same device type can be operated per Vario bus line.

In total, up to 16 access control input/read units can be operated per Vario bus line (controller).

By extending the door communication system to include "digital calls" (DRM 612-.../SKI 700-...), an additional 8 further devices can be operated.

Based on the 4 device types, this means up to 24 devices can be operated per controller.

5 Establishing access control with Vario bus

Range

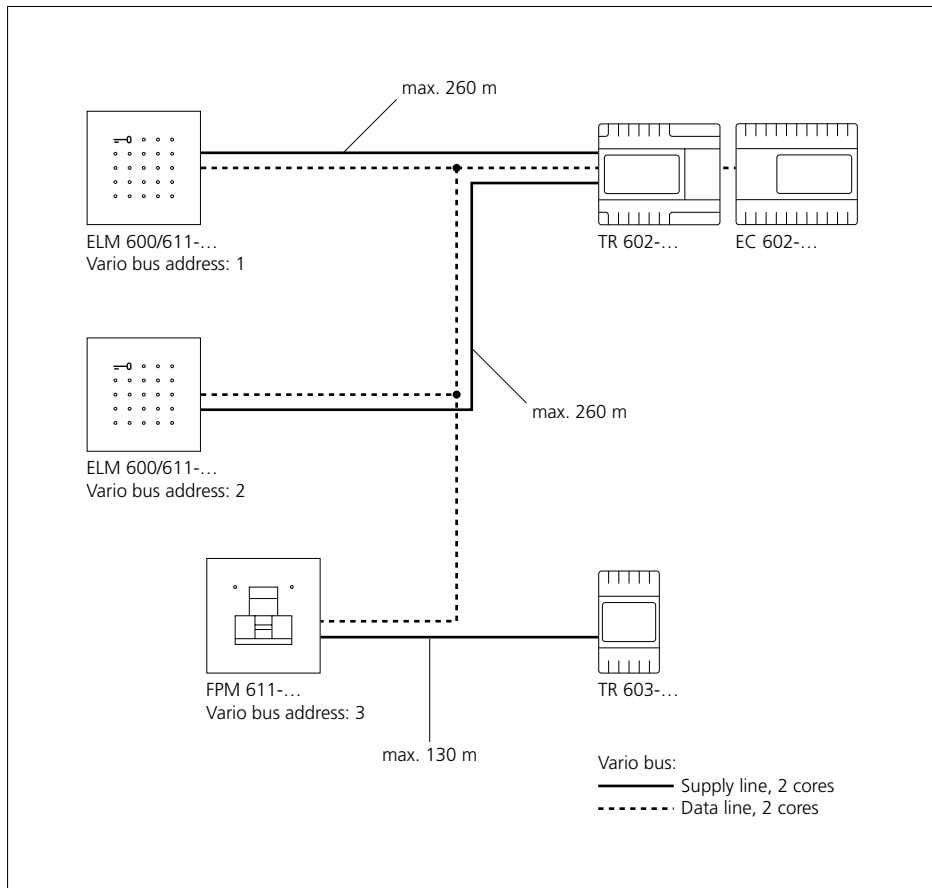

Range of the supply line for star-shaped installation of the supply line (example)

All specifications relating to ranges refer to the above mentioned conductor material with 0.8 mm core diameter.
With a core diameter of 0.6 mm, the range is halved.

The entire length of the data line within a Vario bus line between input/read units and the associated controller is max. 2000 m.

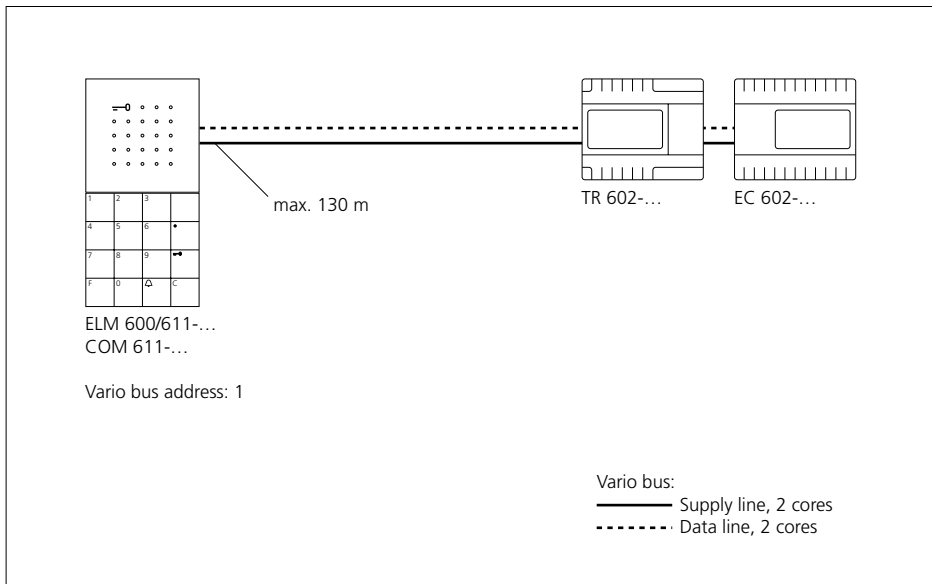

Range of the supply line for bus installation of the supply line with 2 AW (example)

All specifications relating to ranges refer to the above mentioned conductor material with 0.8 mm core diameter.

With a core diameter of 0.6 mm, the range is halved.

The entire length of the data line within a Vario bus line between input/read units and the associated controller is max. 2000 m.

6 System components

Input/read units

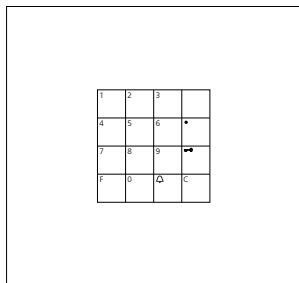

COM 611-02

Code lock module as an input unit for entering codes for door calls and control functions in conjunction with the Siedle Vario bus.

Suitable for:

- Operation with EC 602-... entrance controller for entering codes for control functions and access control.

Programming via PRI 602-... or PRI 602-... USB and PRS 602-...

- Operation with SC 600 controller for entering codes for control functions and access control.

Programming by means of web browser

- Operation with BIM 650-... bus interface module for entering codes for door calls in In-Home bus systems.

Operating elements:

A C button for deleting incorrect entries and a DR button for direct door release. This door release function can also be controlled by a customer-provided timer. LED as status indicator (external potential-free contact).

Operating voltage: 12 V AC

Operating current: max. 140 mA

Protection system: IP 54

Ambient temperature:

-20 °C to +55 °C

Dimensions (mm) W x H x D:

99 x 99 x 27

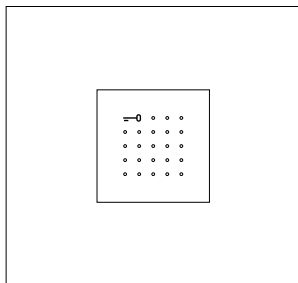

ELM 600-0

Electronic key reading module with MIFARE DESFire EV2 technology as contactless access control system with function LED. Compatible with the new EK/EKC 600-... electronic keys or cards.

As a read unit for electronic keys or cards for opening doors or gates, for example.

Suitable for:

- Stand-alone operation

Max. 9 electronic keys or cards can be used

- Operation with EC 602-... entrance controller or SC 600-... Max. 999 electronic keys or cards can be used

Programming via PRI 602-... USB and PRS 602-...

- Operation with SC 600-... Secure Controller

Max. 500,000 users possible

Programming by means of web browser

Operating voltage: 12 V AC or

12-30 V DC

Operating current: max. 120 mA or max. 50 mA

Contact type: contact 24 V, 2 A

Protection system: IP 54

Ambient temperature:

-20 °C to +55 °C

Dimensions (mm) W x H x D:

99 x 99 x 27

Note

If there are several ELM... in a system, a distance of at least 1 m is required between the modules.

RFID card / RFID tag (electronic key)

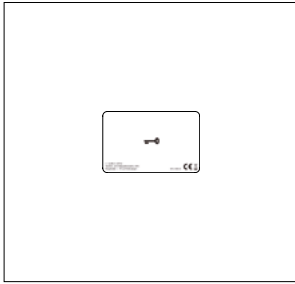

EKC 600-01

Electronic key card in conjunction with the Siedle electronic key reading modules.

EKC 600-01 contains 1 transponder for ELM 600-...

Each electronic card is unique, completely encapsulated and works without battery. The EKC 600-... can only be destroyed by inflicting mechanical damage.

Protection system: IP 67

Ambient temperature:

-20 °C to +55 °C

Dimensions (mm) W x H x D:

85 x 54 x 1

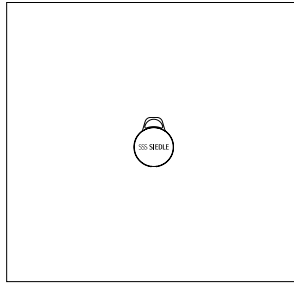

EK 600-01

Electronic key in conjunction with the electronic key reading modules.

EK 600-01 contains 1 transponder for ELM 600-...

Each electronic key is unique, completely encapsulated and works without battery. The EK 600-... can only be destroyed by inflicting mechanical damage.

Protection system: IP 65

Ambient temperature:

-20 °C to +55 °C

Dimensions (mm) W x H x D:

35 x 44 x 4.5

Compatibility matrix

	EK 600-01	EKC 600-01	EK 600-0 (As of 11/2018)	EKC 600-0 (As of 11/2018)
ELM 611-01	-	-	✓	✓
ELM 611-02	-	-	✓	✓
ELM 600-...	✓	✓	✓	✓

Hybrid systems

(a combination of different ELM types in one system)

ELM 611-01 + ELM 611-02	-	-	✓	✓
ELM 611-01 + ELM 600-...	-	-	✓ *	✓ *
ELM 611-02 + ELM 600-...	-	-	✓ *	✓ *

✓ Compatible
- Not compatible

✓ * Compatible, however all old EK/
EKC 601-... must be replaced with
new EK/EKC 600-... to be able to
use all ELM

6.1 System components EC 602-...

Controller and expansion

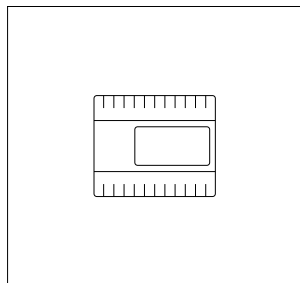

EC 602-03

Entrance controller in switch panel housing for code lock module, electronic key reading module or fingerprint module. Display-supported programming via integrated buttons, or by means of PC software via additional programming interface PRI 602-... Electronic evaluating circuit with 2 switching outputs, extendable to 8 with ECE 602-..., 2 control inputs for time-controlled access rights.

Operating voltage: 12 V AC

Operating current: 150 mA

Contact type: 2 changeover switches 24 V, 2 A

Ambient temperature:

0 °C to +40 °C

Protection system: IP 20

Horizontal pitch (HP): 6

Dimensions (mm) W x H x D:

107 x 89 x 60

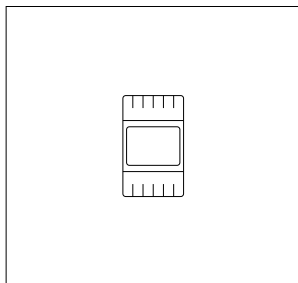

ECE 602-0

ECE 602-0 entrance controller extension in switch panel housing for extending the EC 602-... entrance controller by a further six switching contacts (potential-free normally open contact).

Operating voltage: 12 V AC

Operating current: max. 400 mA

Contact type: 6 n.o. contacts, 24 V, 2 A

Ambient temperature:

0 °C to +40 °C

Protection system: IP 20

Horizontal pitch (HP): 3

Dimensions (mm) W x H x D:

53.5 x 89 x 60

ZRCE 602-0

Ribbon cable, each with plug at either end (appr. 35 cm long). For connection of extension units CCE/RCE/ECE 602-... with the relevant upstream unit with a line skip in the distribution.

Power supply

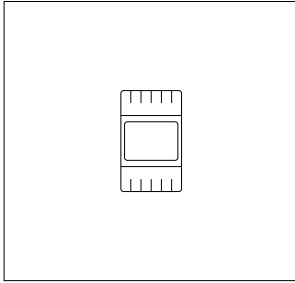

TR 603-0

Transformer in switch panel housing for supplying system and additional components.

Performance features:

- Thermal protection
- Double terminals (secondary)
- Compact design

Operating voltage: 230 V AC, +/-10 %, 50/60 Hz

Operating current: 100 mA

Output voltage: 12 V AC

Output current: max. 1.3 A

Fusing: primary thermal fuse, secondary short circuit proof

Protection system: IP 20

Ambient temperature:

0 °C to +40 °C

Horizontal pitch (HP): 3

Dimensions (mm) W x H x D:

53.5 x 89 x 60

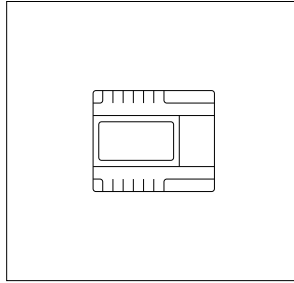

TR 602-01

Transformer in switch panel housing for supplying system and additional components.

Operating voltage: 230 V AC, +/-10 %, 50/60 Hz

Operating current: 170 mA

Output voltage: 12 V AC

Output current: max. 2.5 A

Fusing: primary Si1 T 200 mA L, secondary side with thermal fuse

Protection system: IP 20

Ambient temperature:

0 °C to +40 °C

Horizontal pitch (HP): 6

Dimensions (mm) W x H x D:

107 x 89 x 60

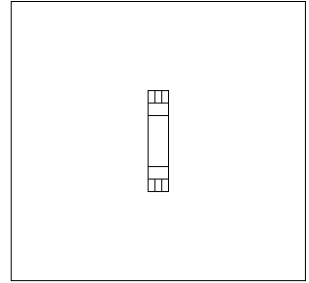

PSM 1 12 24

Line rectifier in switch panel housing for supplying system and additional components.

Operating voltage: 110–240 V AC, 50/60 Hz

Operating current: 265 mA

Output voltage: 24 V DC +/-3 %

Output current: 0.5 A

Fusing: T 0.8

Protection class: II

Ambient temperature:

-10 °C to +50 °C

Horizontal pitch (HP): 1

Dimensions (mm) W x H x D:

17.5 x 96 x 68

6.1 System components EC 602-...

Programming – EC 602-...

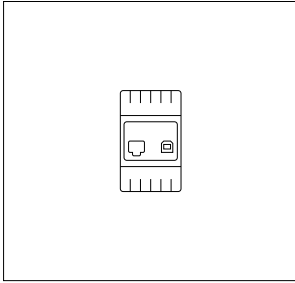

PRI 602-01 USB

The programming interface PRI 602-... USB in a switch panel housing connects a Windows PC via the USB port to the Siedle In-Home bus and the Siedle Vario bus.

System requirements: Windows-PC, Windows 10 or above.

Operating voltage: 10–15 V AC or 10–30 V DC

Protection system: IP 20

Ambient temperature:
0 °C to +40 °C

Horizontal pitch (HP): 3

Dimensions (mm) W x H x D:
53.5 x 89 x 60

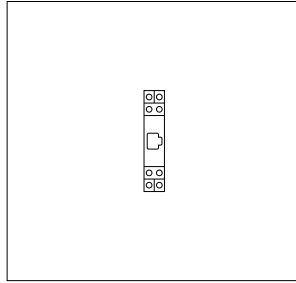

ZWA 640-0

Western socket accessory for switch panel mounting. Integrated socket for 4/6/8-pin western plug.

Protection system: IP 20

Ambient temperature:

0 °C to +40 °C

Horizontal pitch (HP): 1

Dimensions (mm) W x H x D:
18 x 90 x 60

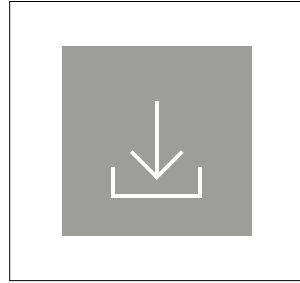

PRS 602-02

Programming software suitable for programming the Vario bus components.

System requirements: Windows PC, operating system Microsoft® Windows 10

Space requirement in the distributor

Models	Unit width
EC 602-...	6
ECE 602-...	3
TR 603-...	3
TR 602-...	6
NG 602-...	6
PRI 602-... USB	3
PSM 1 12 24	1
ZWA 640-...	1

7 Installation

General information

Installation

Siedle access control is an independent system which can be operated in parallel to a door communication system.

The code lock module can be used in parallel operation with access control and the intercom system to enter codes and also make door calls.

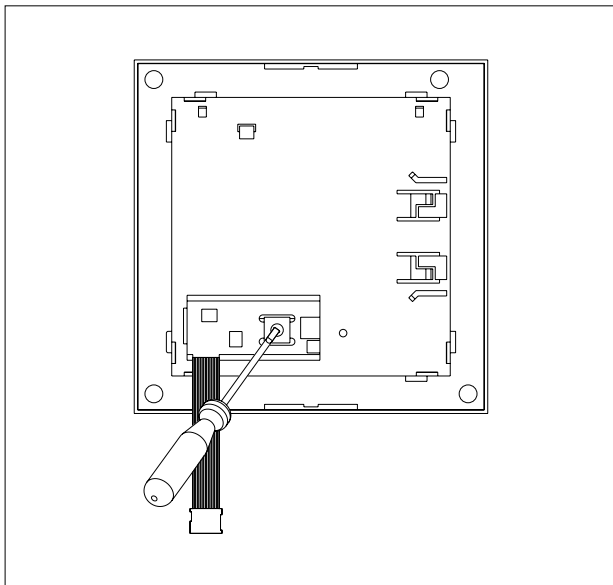

Address setting

There is a rotary switch on the rear of the input/read units for setting the Vario bus address.

In its as-delivered status, address "1" is always pre-set.

If several devices of the same type are to be operated on the same Vario bus system, a different Vario bus address (1 to 8) must be set for each device.

The Vario bus address setting "0" and "9" as well as the same Vario bus addresses for the same device types (e.g. 2x COM 611-... with address "2"), lead to malfunctions within the Vario bus and therefore must not be used.

Different input/read units which are combined on a door station (e.g. COM... and ELM...) each receive the same address.

7 Installation

Basic circuit diagram, stand-alone operation with ELM 600/611-... and DSC 602-...

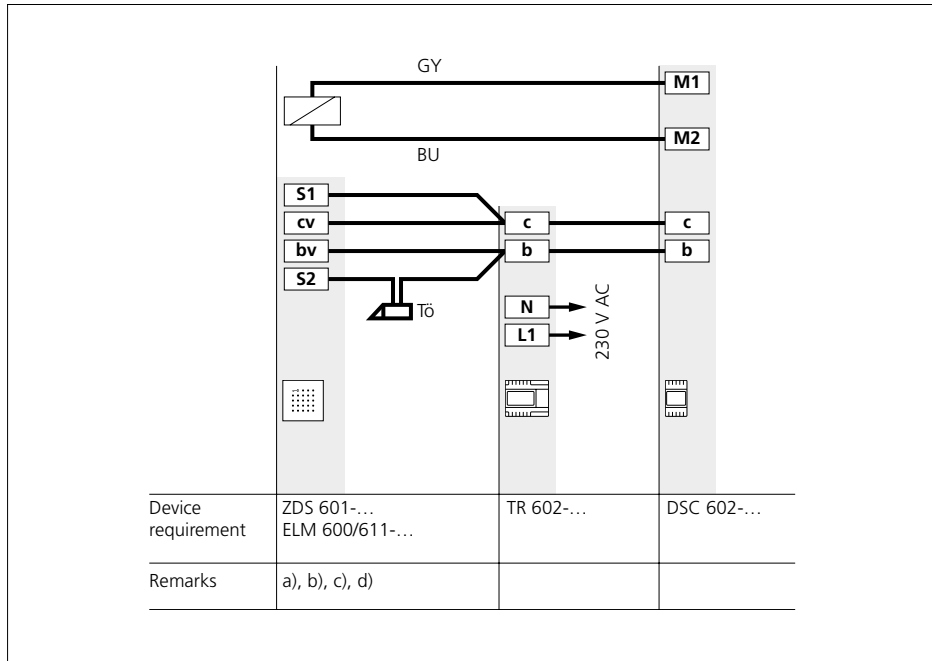

Notes on the circuit diagram

a) Pilfer safeguard for installation in the MR 611-... mounting frame. For tamper-proof operation of the read unit.

b) To prevent burglaries, we recommend the use of a motorised lock according to current guidance (resistance class RC 2) instead of a door release.

If a standard door release is to be used, use a 12 V AC door release with an impedance of min. 20 Ohm (e.g. TÖ 615-...).

c) Supply line length (supply unit – ELM) max. 260 m
Ranges can be found on page onwards 31.

d) ELM are only functional when installed.

For ELM in the Siedle Vario design line this means, for example, that they must be snapped into the MR 611-...mounting frame.

Basic circuit diagram, stand-alone operation with FPM 600-... and DSC 602-...

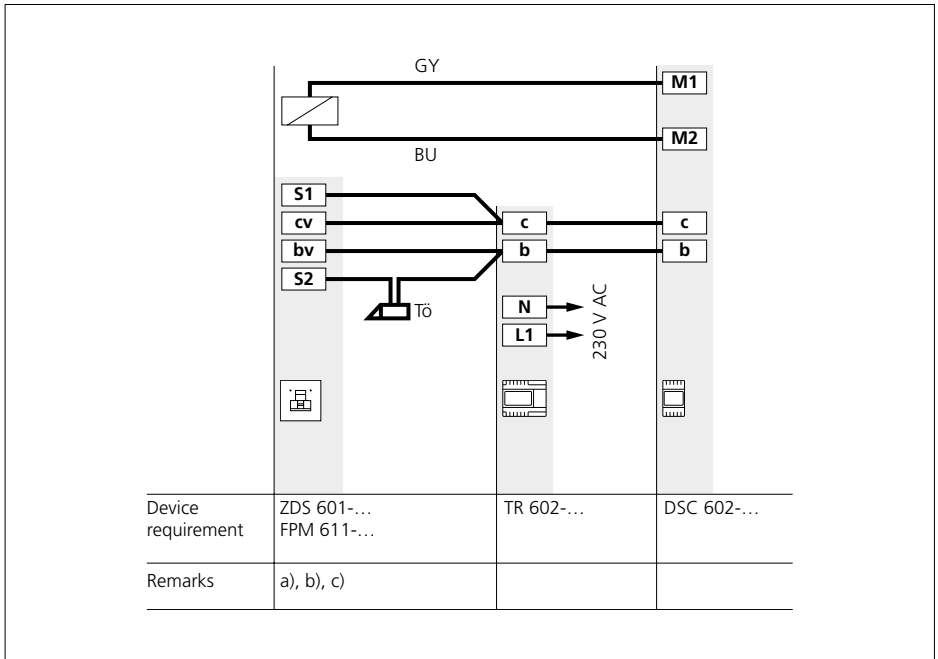

Notes on the circuit diagram

a) Pilfer safeguard for installation in the MR 611-... mounting frame. For tamper-proof operation of the read unit.

b) To prevent burglaries, we recommend the use of a motorised lock according to current guidance (resistance class RC 2) instead of a door release.

If a standard door release is to be used, use a 12 V AC door release with an impedance of min. 20 Ohm (e.g. TÖ 615-...).

c) Supply line length (supply unit – FPM) max. 130 m
Ranges can be found on page onwards 31.

7.1 Installation EC 602-...

Basic circuit diagram EC 602-...

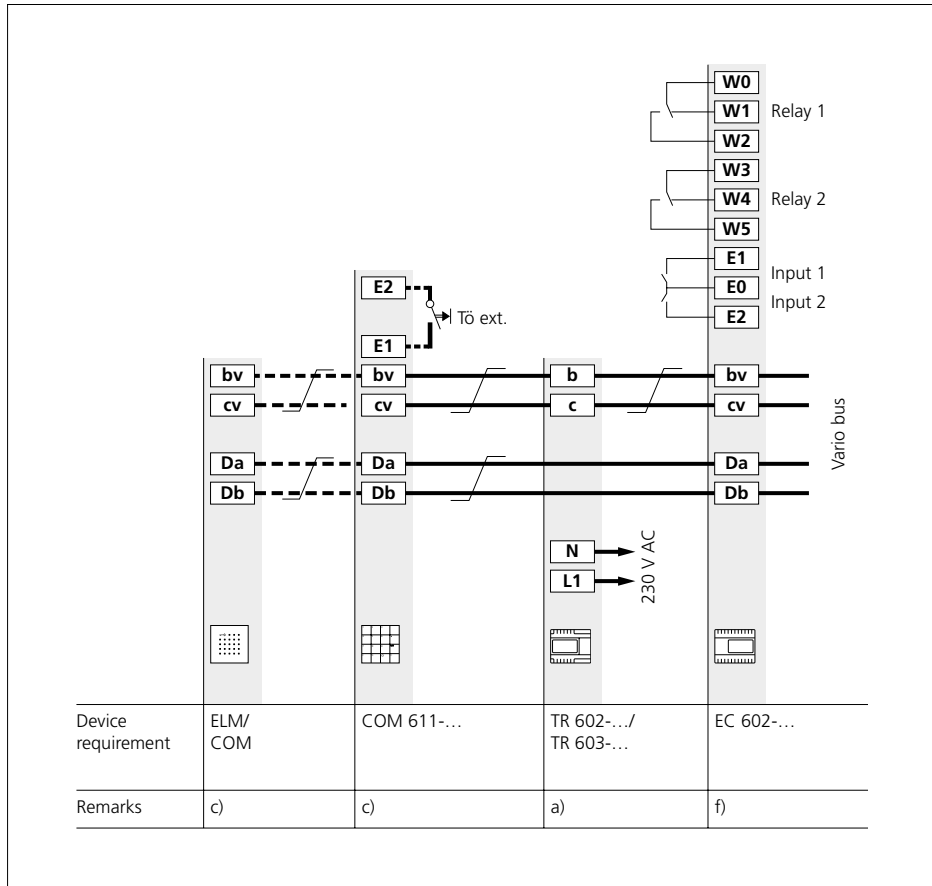

Supplementary functions in EC mode

• Internal key button on COM 611-...

If required, the key button on the COM 611-... can be configured. This makes it possible to trigger the door release function without entering a valid code.

This can also be optionally time controlled with timer.

To use this function, the EC 602-... entrance controller must be configured accordingly.

For more information, see page 70.

• External button on COM 611-...

An external key button can be connected to the COM 611-.... To use this function, the E2/E0 contact of the EC 602-... entrance controller must be closed (e.g. controlled via a timer).

For more information, see page 70.

• Input block

An input block can be configured via the EC 602-... entrance controller.

When this is activated, switching functions are only triggered by the EC 602-... when the E1/E0 contact on the EC 602-... is closed.

A timer can thus be used to control when access is allowed.

For more information, see page 69.

Notes on the circuit diagram

a) Depending on the application, additional TR 602-... or TR 603-... transformers must be provided. Ranges can be found on page onwards 31.

c) Access control line lengths:
Supply line (supply unit – input/read unit) max. 260 m (depending on the “AW” connection load values of the input/read units and the installation type).

Data line max. 2000 m
Detailed information about the line lengths can be found on page onwards 31.

f) Programming and reading in of codes/RFID cards/ RFID tags manually via EC or via PC.

For more information, see page 66.

Supplementary functions in EC mode

• Internal key button on COM 611-...

If required, the key button on the COM 611-... can be configured. This makes it possible to trigger the door release function without entering a valid code.

This can also be optionally time controlled with timer.

To use this function, the EC 602-... entrance controller must be configured accordingly.

For more information, see page 70.

• External button on COM 611-...

An external key button can be connected to the COM 611-.... To use this function, the E2/E0 contact of the EC 602-... entrance controller must be closed (e.g. controlled via a timer).

For more information, see page 70.

• Input block

An input block can be configured via the EC 602-... entrance controller.

When this is activated, switching functions are only triggered by the EC 602-... when the E1/E0 contact on the EC 602-... is closed.

A timer can thus be used to control when access is allowed.

For more information, see page 69.

Notes on the circuit diagram

a) Depending on the application, additional TR 602-... or TR 603-... transformers must be provided. Ranges can be found on page onwards 31.

c) Access control line lengths: Detailed information about the line lengths can be found on page onwards 31.

e) The EC 602-... is connected to the ECE 602-... using a plug-in ribbon cable which is supplied with the ECE 602-...

If the distance between the EC 602-... and ECE 602-... is too large and a longer ribbon cable (max. 35 cm) is required, this can be requested using designation ZRCE 602-0.

f) Programming and reading in of codes/RFID cards/ RFID tags manually via EC or via PC.

For more information, see page 66.

7.1 Installation EC 602-...

2 Door stations

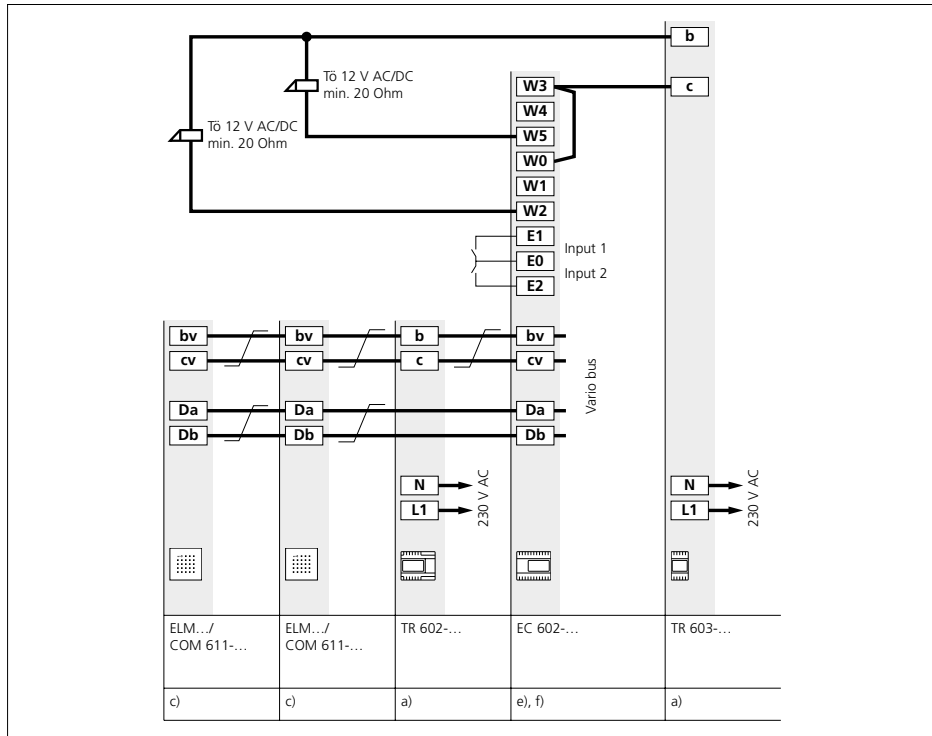

Notes on the circuit diagram

a) Depending on the application, additional TR 602-... or TR 603-... transformers must be provided. Ranges can be found on page onwards 31.

b) To prevent burglaries, we recommend the use of a motorised lock according to current guidance (resistance class RC 2) instead of a door release.

If a standard door release is to be used, use a 12 V AC door release with an impedance of min. 20 Ohm (e.g. TÖ 615-...).

c) Access control line lengths: Detailed information about the line lengths can be found on page onwards 31.

e) The EC 602-... is connected to the ECE 602-... using a plug-in ribbon cable which is supplied with the ECE 602-...

If the distance between the EC 602-... and ECE 602-... is too large and a longer ribbon cable (max. 35 cm) is required, this can be requested using designation ZRCE 602-0.

f) Programming and reading in of codes/RFID cards/ RFID tags manually via EC or via PC.

For more information, see page 66.

4 Door stations

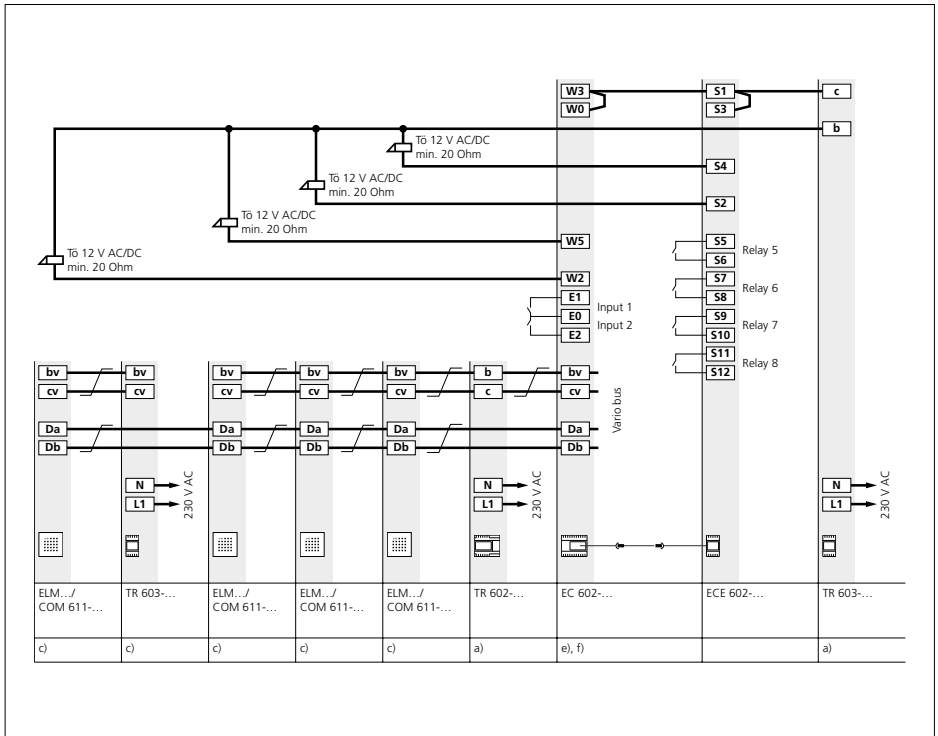

Notes on the circuit diagram

a) Depending on the application, additional TR 602-... or TR 603-... transformers must be provided.

Ranges can be found on page onwards 31.

b) To prevent burglaries, we recommend the use of a motorised lock according to current guidance (resistance class RC 2) instead of a door release.

If a standard door release is to be used, use a 12 V AC door release with an impedance of min. 20 Ohm (e.g. TÖ 615-...).

c) Access control line lengths: Detailed information about the line lengths can be found on page onwards 31.

e) The EC 602-... is connected to the ECE 602-... using a plug-in ribbon cable which is supplied with the ECE 602-...

If the distance between the EC 602-... and ECE 602-... is too large and a longer ribbon cable (max. 35 cm) is required, this can be requested using designation ZRCE 602-0.

f) Programming and reading in of codes/RFID cards/ RFID tags manually via EC or via PC.

For more information, see page 66.

7.1 Installation EC 602-...

Access Professional – 1 Door station

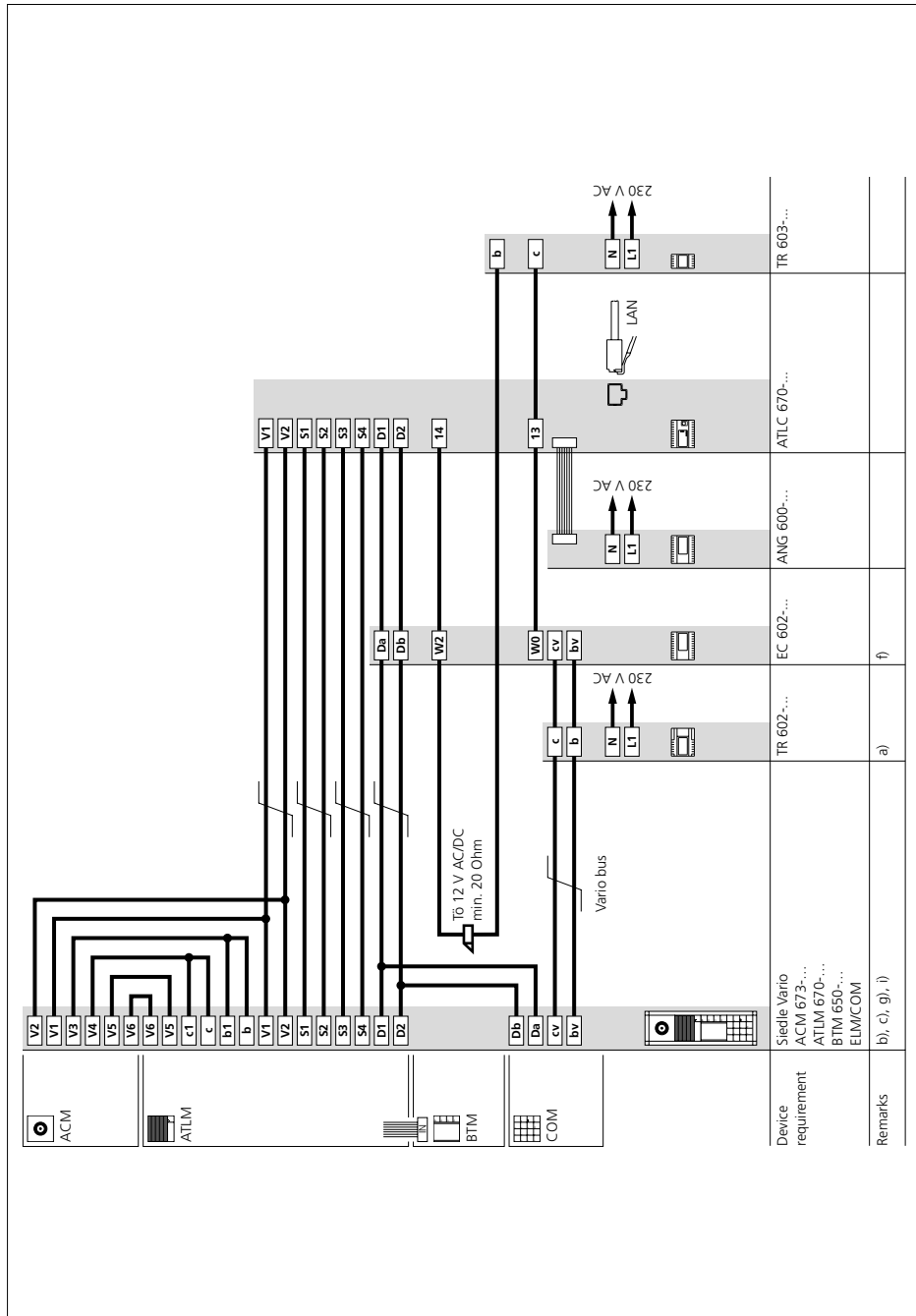

Notes on the circuit diagram

a) To ensure smooth operation, the Vario bus input/read units and the EC 602-... entrance controller must be supplied with their own power supply.

Depending on the application, additional TR 602-... or TR 603-... transformers must be provided. Ranges can be found on page onwards 31.

b) To prevent burglaries, we recommend the use of a motorised lock according to current guidance (resistance class RC 2) instead of a door release.

If a standard door release is to be used, use a 12 V AC door release with an impedance of min. 20 Ohm (e.g. TÖ 615-...).

c) Access control line lengths: Detailed information about the line lengths can be found on page onwards 31.

f) Programming and reading in of codes/RFID cards/ RFID tags manually via EC or via PC.

For more information, see page 66.

g) The COM 611-... code lock module is always available for making calls (direct dial via numeric code).

Together with the EC 602-... entrance controller, additional control functions (e.g. access control) can be carried out for this door station.

i) If, in the case of several door stations with COM 611-..., only control functions (access control) are run, the Da/Db terminals of the COM 611-... and EC 602-... must be connected directly to one another (without connection to D1/D2). Only in this case may the COM 611-.../EC 602-... of the various door stations be interconnected to a group.

The Access Professional Planning and System Manual, which can be found in the download section, contains detailed information about installation and commissioning for the intercom system.

7.1 Installation EC 602-...

Access Professional – 2 Door stations

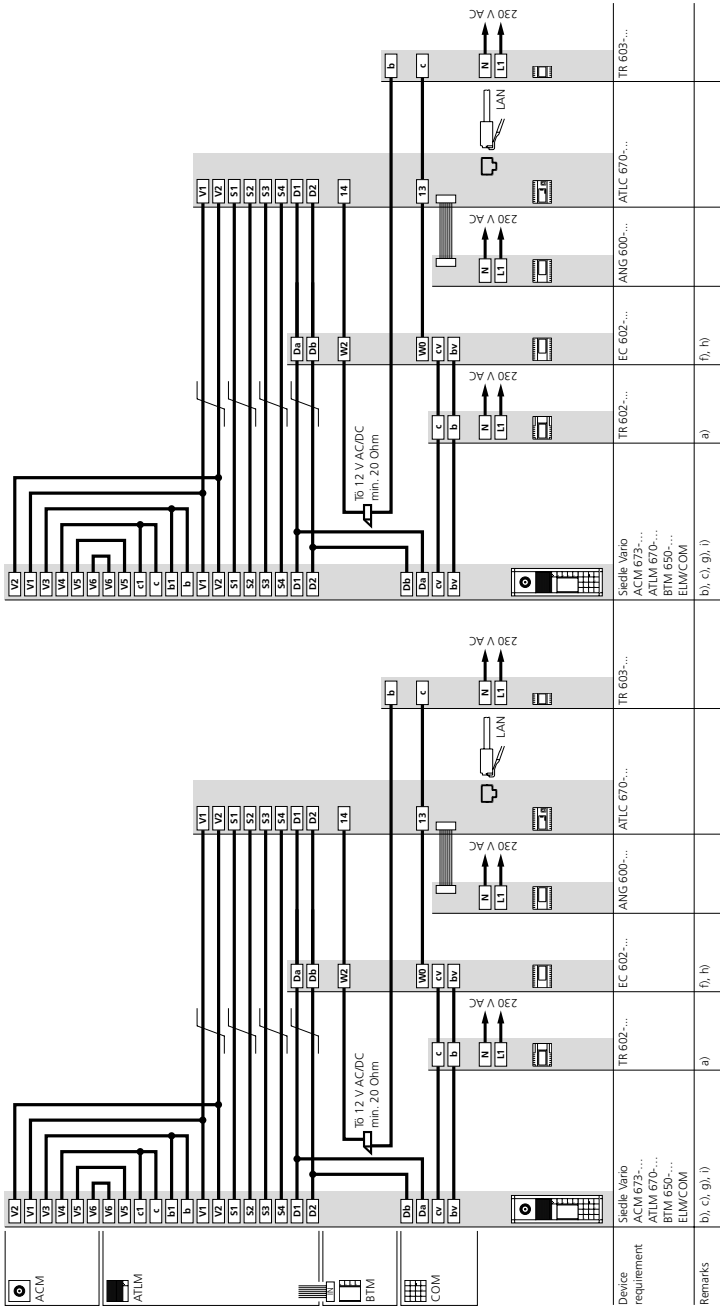

Notes on the circuit diagram

a) To ensure smooth operation, the Vario bus input/read units and the EC 602-... entrance controller must be supplied with their own power supply.

Depending on the application, additional TR 602-... or TR 603-... transformers must be provided. Ranges can be found on page onwards 31.

b) To prevent burglaries, we recommend the use of a motorised lock according to current guidance (resistance class RC 2) instead of a door release.

If a standard door release is to be used, use a 12 V AC door release with an impedance of min. 20 Ohm (e.g. TÖ 615-...).

c) Access control line lengths: Detailed information about the line lengths can be found on page onwards 31.

f) Programming and reading in of codes/RFID cards/ RFID tags manually via EC or via PC.

For more information, see page 66.

g) The COM 611-... code lock module is always available for making calls (direct dial via numeric code).

Together with the EC 602-... entrance controller, additional control functions (e.g. access control) can be carried out for this door station.

h) If it is to be possible to execute both control functions (access control) and call functions (door communication) on several doors in a property, then a separate EC 602-... entrance controller is required for each of these doors with control functions.

In this case, the EC 602-... for the individual doors must not be connected to one another.

i) If, in the case of several door stations with COM 611-..., only control functions (access control) are run, the Da/Db terminals of the COM 611-... and EC 602-... must be connected directly to one another (without connection to D1/D2). Only in this case may the COM 611-.../EC 602-... of the various door stations be interconnected to a group.



In the case of several door stations, the wiring of one door station must not be connected to the wiring of another door station (bridged).

The Access Professional Planning and System Manual, which can be found in the download section, contains detailed information about installation and commissioning for the intercom system.

Notes on the circuit diagram

a) To ensure smooth operation, the Vario bus input/read units and the EC 602-... entrance controller must be supplied with their own power supply.

Depending on the application, additional TR 602-... or TR 603-... transformers must be provided. Ranges can be found on page onwards 31.

b) To prevent burglaries, we recommend the use of a motorised lock according to current guidance (resistance class RC 2) instead of a door release.

If a standard door release is to be used, use a 12 V AC door release with an impedance of min. 20 Ohm (e.g. TÖ 615-...).

c) Access control line lengths: Detailed information about the line lengths can be found on page onwards 31.

f) Programming and reading in of codes/RFID cards/ RFID tags manually via EC or via PC.

For more information, see page 66.

g) Control functions (e.g. access control) can be executed for this door station using the COM 611-... code lock module and the EC 602-... entrance controller.

If the COM is also to be used for making calls (direct dial via numeric code), then a BIM 650-... bus interface module is required. (See page 58)

The Siedle In-Home bus System Manual, which can be found in the download section, contains detailed information about installation and commissioning for the intercom system.

Door release actuation

In deviation from the standard plans, the door release can be actuated in various ways. The bus line rectifier BNG/BVNG 650-... has a DR contact which is closed every time the door release button is actuated. At the door loudspeakers BTLM 65x-... and BTLE 050-... there is also a door release contact which is only closed when the bell has previously been rung at the relevant door loudspeaker. If several door loudspeakers are operated within a system, both contacts are required to open the door station. In general, high-resistance door releases must be used in order to guarantee the greatest possible degree of operating reliability/ the greatest possible range. Use a Siedle door release or a 12 V AC door release with an impedance of at least 20 Ohm.

Application

Door release – not tamper-proof

Garden gate or areas without security relevance.

The DR contact in the door loudspeaker switches every time the door release button is pressed.

Benefits

- Several door stations possible without additional installation

Drawbacks

- Not tamper-proof, as access possible from outside

Door release – tamper-proof / with motorised lock

Systems with more than one door station with door release.

The Tö contact (door release contact) in the bus line rectifier and the door release contact in the door loudspeaker are used. The contact in the BNG/BVNG 650-... switches the door release button every time it is pressed, the contact in the door loudspeaker only at the door from which the last door call was placed.

Benefits

- Tamper-proof, as no access from the outside

Drawbacks

- The door release must be routed to the distributor
- If there is more than one door station, an ECE 602-... is required. Max. 7 doors can be managed per EC 602-... (+ ECE 602-...).

Note

The relay on the EC 602-... / ECE 602-... which is connected in parallel to the terminal TÖ/TÖ on BNG/BVNG 650-... (here terminal S3/S4 / relay 4), must be operated "globally".

Otherwise, the door release contact on the door station cannot be triggered.

Notes on the circuit diagram

a) Depending on the application, additional TR 602-... or TR 603-... transformers must be provided.

b) To prevent burglaries, we recommend the use of a motorised lock according to current guidance (resistance class RC 2) instead of a door release.

If a standard door release is to be used, use a 12 V AC door release with an impedance of min. 20 Ohm (e.g. TÖ 615-...).

c) Access control line lengths: Detailed information about the line lengths can be found on page onwards 31.

e) The EC 602-... is connected to the ECE 602-... using a plug-in ribbon cable which is supplied with the ECE 602-...

If the distance between the EC 602-... and ECE 602-... is too large and a longer ribbon cable (max. 35 cm) is required, this can be requested using designation ZRCE 602-0.

f) Programming and reading in of codes/RFID cards/ RFID tags manually via EC or via PC.

For more information, see page 66.

The Siedle In-Home bus System Manual, which can be found in the download section, contains detailed information about installation and commissioning for the intercom system.

Switching contact definition

Switching contact 1 Local

Switching contact 2 Local

Switching contact 3 Local

Switching contact 4 Global

In-Home bus – 3 Door stations (with motorised lock)

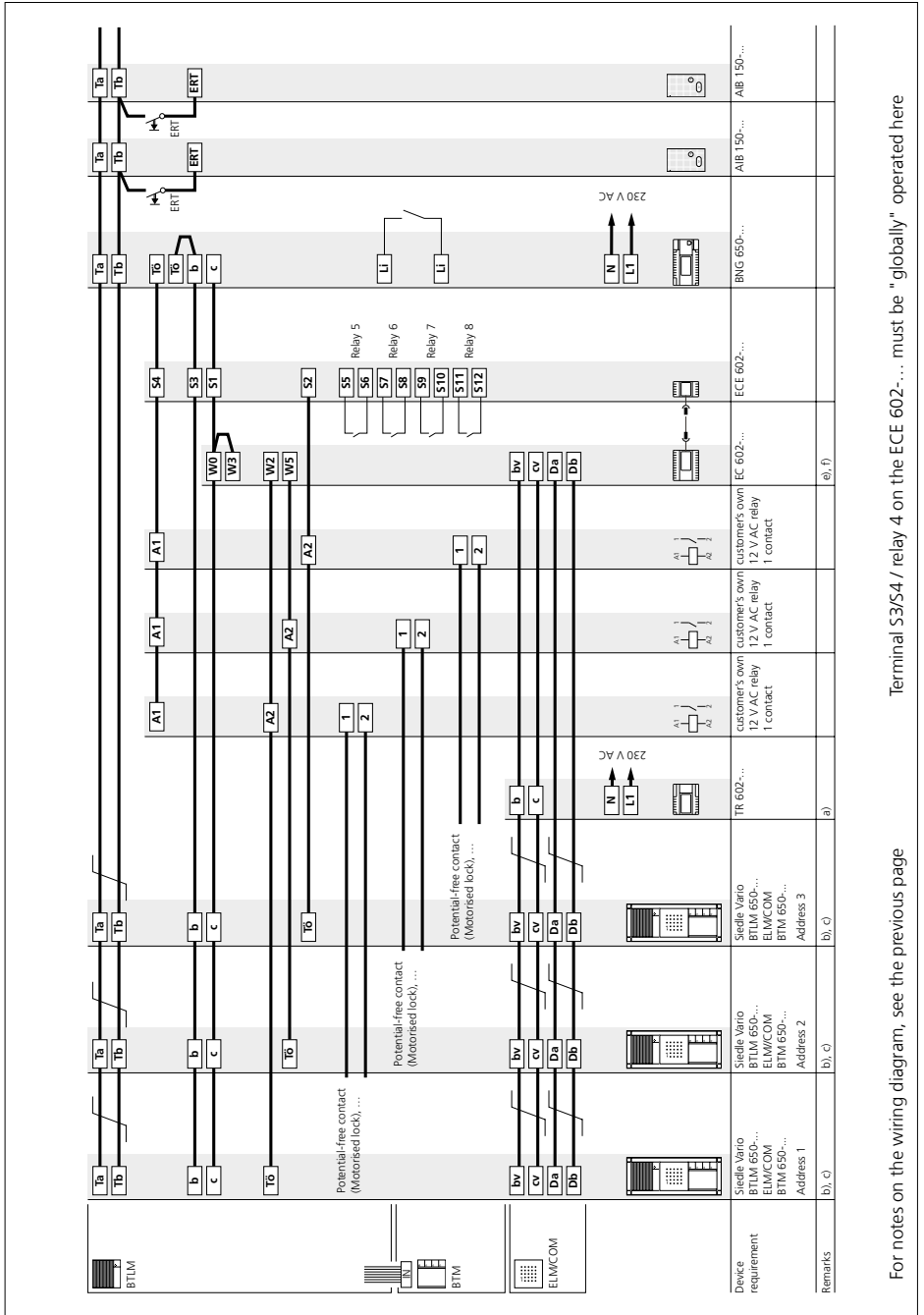

Terminal S3/S4 / relay 4 on the ECE 602-... must be "globally" operated here

For notes on the wiring diagram, see the previous page

Notes on the circuit diagram

a) To ensure smooth operation, the Vario bus input/read units and the EC 602-... entrance controller must be supplied with their own power supply.

Depending on the application, additional TR 602-... or TR 603-... transformers must be provided. Ranges can be found on page onwards 31.

b) To prevent burglaries, we recommend the use of a motorised lock according to current guidance (resistance class RC 2) instead of a door release.

If a standard door release is to be used, use a 12 V AC door release with an impedance of min. 20 Ohm (e.g. TÖ 615-...).

c) Access control line lengths: Detailed information about the line lengths can be found on page onwards 31.

f) Programming and reading in of codes/RFID cards/ RFID tags manually via EC or via PC.

For more information, see page 66.

g) Control functions (e.g. access control) can be executed for this door station using the COM 611-... code lock module and the EC 602-... entrance controller.

If the COM is also to be used for making calls (direct dial via numeric code), then a BIM 650-... bus interface module is required.

h) Configuration of the "digital calls" function manually or via PC (using the BPS 650-... bus programming software).

For more information, please refer to the System Manual In-Home-Bus.

i) To use the call function of the COM 611-... (call via number entry), the terminals 1/6 of the COM 611-... must be connected to the terminals GND/CD6 of the BTLM 650-...

The Siedle In-Home bus System Manual, which can be found in the download section, contains detailed information about installation and commissioning for the intercom system.

7.2 Installation SC 600-...

Basic circuit diagram SC 600-... – 4 Door stations

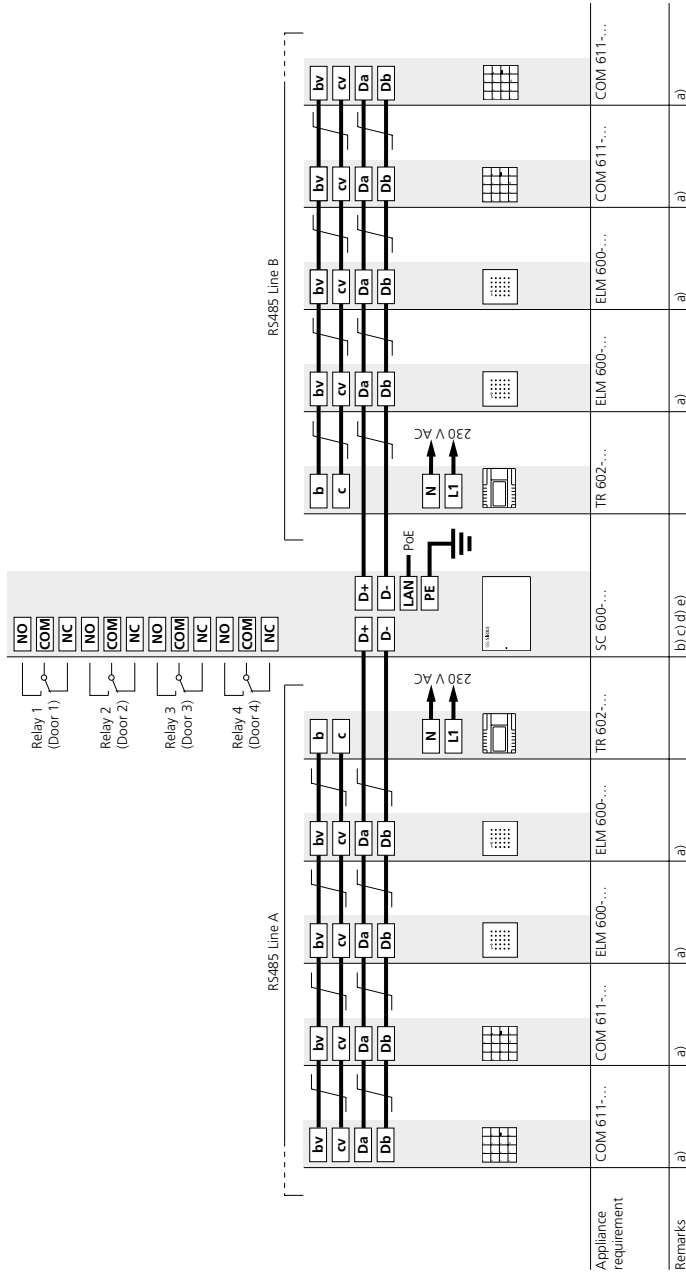

Notes on the circuit diagram

- a)** A maximum of 8 modules can be connected per RS485 line. Ranges can be found on page onwards 31.
- b)** Alternative supply via the PSM 1 12 24 line rectifier.
- c)** The housing's PE earthing connection must be connected.
- d)** Simultaneous supply via PoE and line rectifier is not permitted!
- e)** Observe jumper position SW6 (24 V).

Detailed information about the line lengths can be found on page onwards 31.

The Siedle In-Home bus System Manual, which can be found in the download section, contains detailed information about installation and commissioning for the intercom system.

7.2 Installation SC 600-...

SC 600-... + 2 SE 600-... – Secure Extension as an extension for the Secure Controller

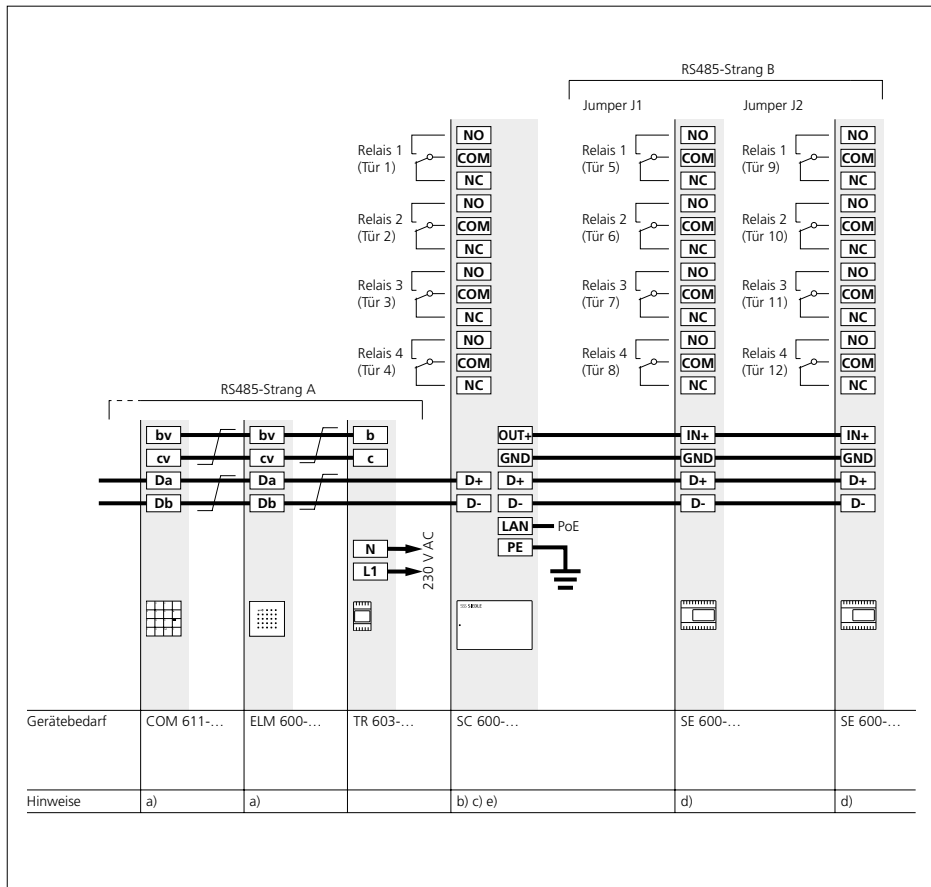

Notes on the circuit diagram

- a)** A maximum of 8 modules can be connected per RS485 line.
- b)** Alternative supply via the PSM 1 12 24 line rectifier. Simultaneous supply via PoE and line rectifier is not permitted!
- c)** The housing's PE earthing connection must be connected.
- d)** Address setting via jumper position J1 (door 5-8) or J2 (door 9-12), each address must only be used once per line.

The Siedle In-Home bus System Manual, which can be found in the download section, contains detailed information about installation and commissioning for the intercom system.

Note

- Conductor material J-Y(St)Y cable with 0.8 mm diameter:
- max. 150 m from the Secure Controller SC 600-... to the most distant Secure Extension SE 600-... With a core diameter of 0.6 mm, the range is halved.

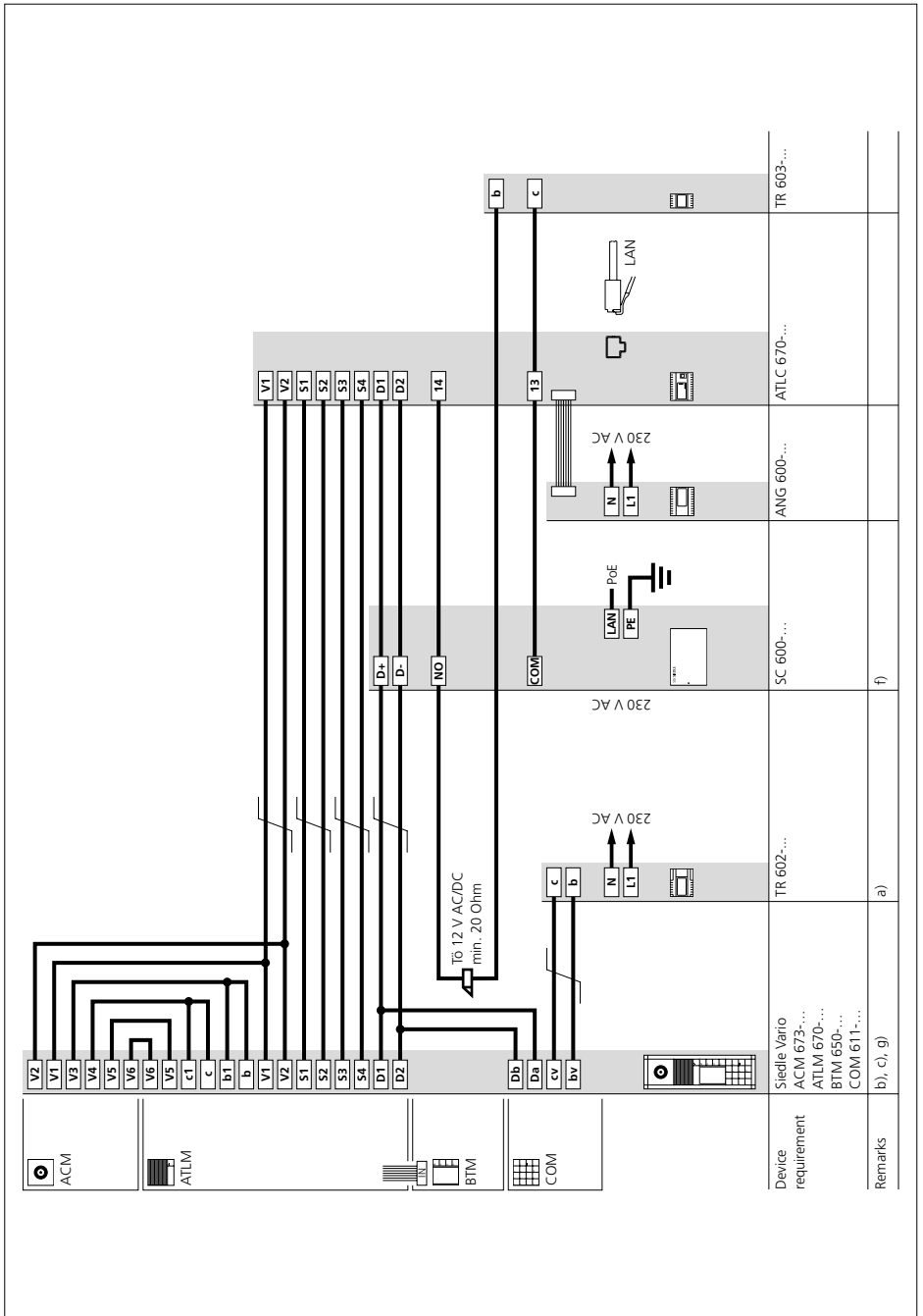

7.2 Installation SC 600-...

Access Professional – 1 Door station

Notes on the circuit diagram

a) To ensure smooth operation, the Vario bus input/read units and the SC 600 Secure Controller must be supplied with their own power supply.

Depending on the application, additional TR 602-... or TR 603-... transformers must be provided. Ranges can be found on page onwards 31.

b) To prevent burglaries, we recommend the use of a motorised lock according to current guidance (resistance class RC 2) instead of a door release.

If a standard door release is to be used, use a 12 V AC door release with an impedance of min. 20 Ohm (e.g. TÖ 615-...).

c) Access control line lengths: Detailed information about the line lengths can be found on page onwards 31.

f) Programming and reading of codes/RFID cards/RFID tags via the administration interface. Detailed information can be found in the SC 600-... commissioning instructions.

g) The COM 611-... code lock module is always available for making calls (direct dial via numeric code).

Together with the SC 600-..., additional control functions (e.g. access control) can be executed for this door station.

If you want to be able to carry out control functions (access control) as well as call functions (door communication) on several doors in a property, one door can be connected to each of the two Vario bus lines (A/B) on the SC 600-... Therefore two doors are possible per SC 600-... For more than two doors, additional SC 600-... are required. The SC 600-... must be connected to each other via the Ethernet connection. Caution: The SC 600-... must not be connected via the Vario bus!

If, in the case of several door stations with COM 611-..., only control functions (access control) are run, the Da/Db terminals of the COM 611-... and SC 600-... must be connected directly to one another (without connection to D1/D2). Only in this case may the COM 611-.../SC 600-... of the various door stations be interconnected to a group.



In the case of several door stations, the wiring of one door station must not be connected to the wiring of another door station (bridged).

The Access Professional Planning and System Manual, which can be found in the download section, contains detailed information about installation and commissioning for the intercom system.

8 Programming

8.1 General

Depending on the operating mode (stand-alone operation, operation with EC 602-..., operation with SC 600-...), the Siedle access control can be programmed manually and/or with PC. In the case of operation with SC 600-... only programming via PC is possible.

Important remarks prior to programming

- The entire installation must have been completed.
- All supply units must be connected to mains voltage 230 V AC.
- If several input/read units of the same type (e.g. several COM 611-... or several ELM...) are used in a system, a different address must be set on each of the input/read units. Addresses "0" and "9" are not permitted!
- COM 611-... and/or ELM... and/or FPM 611-..., which are combined on a door station, each receive the same address.
- All system components are ready for operation.

8.2 Stand alone operation

In stand-alone operation, the door can either be opened via ELM or FPM.

The Siedle access control is programmed manually in stand-alone operation.

Detailed information about installation and programming for the ELM or FPM can be found in the relevant product information.

8.3 Operation with entrance controller EC 602-...

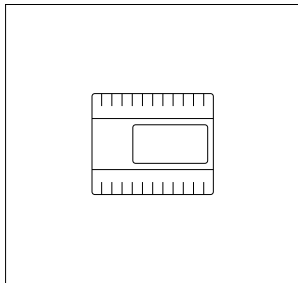

Up to 8 doors can be managed via the EC 602-... entrance controller (with the ECE 602-... entrance controller extension).

The EC 602-... is a central element for controlling the Siedle access control:

It is used as electronic evaluating circuit and switching unit in conjunction with the code lock module, the electronic key reading module, the fingerprint module and the display call module (when an external button is connected as key button).

The Siedle access control can be programmed with the EC 602-... entrance controller in two ways:

1 Programming – manual

For more information, see page 66.

2 Programming – with PC

For more information, see page 67.

Programming – manual

Manual programming of the COM 611-... and ELM... is carried out via the EC 602-... entrance controller (display-supported programming via integrated buttons).

Remarks

- Cards or fingerprints must always be read in via the corresponding read unit with the lowest Vario bus address.

Detailed information about manual programming can be found in the EC 602-... programming instructions.

Programming – with PC

If the EC 602-... entrance controller is used, then all the functions of the Siedle access control can be programmed using a Windows PC. The PRS 602-... programming software is used for programming. The PC can be connected to the Vario bus via the PRI 602-... programming interface USB.

Connection via programming interface PRI 602-... USB

The PRI 602-... USB is connected to the PC using the USB connecting cable, which is supplied with the PRI 602-... USB. The PRI 602-... USB can either be permanently installed in a system or plugged in using an 8-pin Western socket (mobile operation).

Note

The PRI 602-... USB may be connected either solely using the cables and sockets or using the terminals on the Siedle Vario bus. There is a risk of short circuit if connected simultaneously via terminals and sockets – if the cores are mixed-up.

Remarks

- If data transmission is not possible (e.g. no devices are found), then it usually helps to briefly remove all the connections on the PRI 602-... USB.
- For details on commissioning with the PRS 602-... programming software, please see the online help for the software.

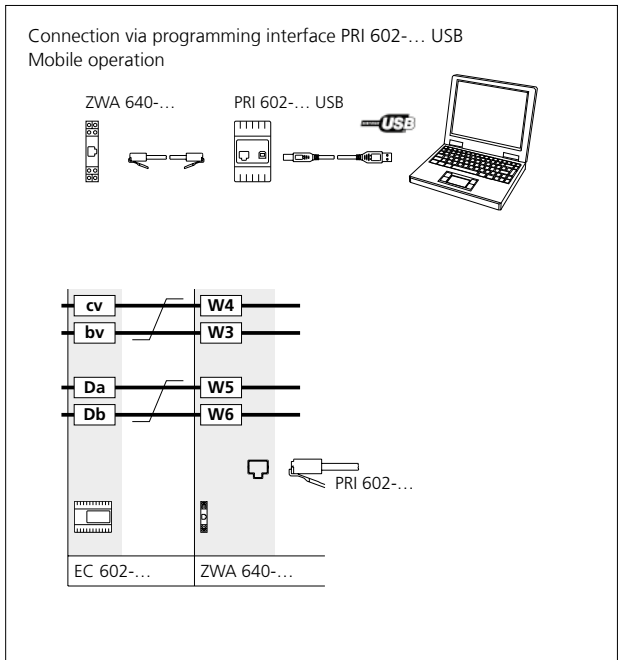
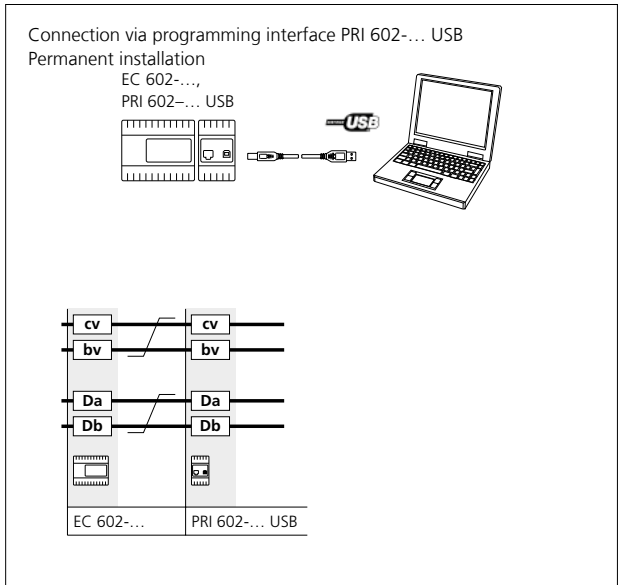

8.3 Operation with entrance controller EC 602-...

Switching and control functions

Switching outputs

On the EC 602-..., there are 2 potential-free switching outputs (relay changeover contact) relay 1 and relay 2. The EC 602-... can be extended with 6 normally open contacts through an ECE 602-... entrance controller extension.

In the EC 602-... and ECE 602-..., each relay is assigned a unique relay number and Vario bus address:

Model	Relay number	Vario bus address
EC 602-...	1	1
	2	2
ECE 602-...	3	3
	4	4
	5	5
	6	6
	7	7
	8	8

The relays can be energised by entering a code on the COM 611-..., by reading in an RFID card/an RFID tag on the ELM..., by recognising a read-in fingerprint on the FPM 611-... or by pressing the key button on the COM 611-...

The relays can be operated locally or globally.

- **LOCAL:** If a relay is operated locally, it can only be triggered by the associated input/read unit via code, RFID card/RFID tag, fingerprint or key button.

Example

2 COM 611-... are operated (Vario bus address 1 and 2). Relay 2 is configured locally and assigned to code 01.
System behaviour: Relay 2 only switches if code 01 is entered via the COM with Vario bus address "2".

- **GLOBAL:** If a relay is operated globally, then it can be triggered with the assigned code, RFID card/RFID tag, fingerprint or key button from each input/read unit, regardless of its Vario bus address (e.g. it needs to be possible to open an access door from both sides using one input device each with the same code).

Example

2 COM 611-... are operated (Vario bus address 1 and 2). Relay 1 is configured globally and relay 2 is configured locally. Relay 1 is assigned to code 01, relay 2 is assigned to code 02 and relay 1 and 2 is assigned to code 03.
System behaviour: If code 01 or 03 is entered via one of the two COM..., then relay 1 is triggered.
Relay 2 is only triggered when code 02 or 03 is entered via the COM... with Vario bus address "2".

Operation without extension

If the EC 602-... is operated without an ECE 602-..., then, in the case of a local relay configuration, a maximum of two identical input/read units (COM/ELM/FPM) can be operated. Each additional input/read unit of the same type must be operated globally. Up to 8 COM 611-..., 8 ELM... and 8 FPM 611-... can be managed by one EC 602-.... If more than two input/read units of the same type are to be operated locally, an ECE 602-... is required.

Switching inputs

The two switching inputs E1 and E2 are located on the EC 602-...
Certain codes and/or internal and external key buttons can be released (manually or time-controlled) independently of one another via these switching inputs.

- Switching input E1 (disables all access options globally): If the contact is open, the access option is blocked for all factors (code, RFID card/RFID tag, fingerprint, key button), for which the block was configured.
- Switching input E2 (key button enable): Connected key buttons only work when the contact is closed (COM 611-... or externally via button).

Priority control

If both control inputs are wired, E1 has priority.
The block for the key buttons via input 1 continues to be effective even in the case of general release of key buttons via input 2.



External voltage must not be applied to the control inputs E1 and E2.

The circuit is made through potential-free contacts between E0/E1 or E0/E2.

Input block

An input block can be configured via the E1 switching input on the EC 602-... For example, this can be used to prevent access at the weekend using valid factors (code, RFID card/RFID tag, fingerprint) or when access via the factors is only to be permitted at specific times. A connected timer is required to use the input block.

If the contact is open, the access option is blocked for all factors (code, RFID card/RFID tag, fingerprint, key button), for which the block was configured.

The block for access via code and/or RFID cards and RFID tags (electronic key) can be programmed both manually via the EC 602-... and via PC (PRS 602-...).

If a fingerprint module is used, the programming must be carried out on the PC (PRS 602-...).

For each factor (code, RFID card/RFID tag, fingerprint), the door(s) that is/are to be openable and whether the input block is to be active when the contact E1/E0 (on EC 602-...) is open must be specified.

Remarks

- If the input block is only to be used for key buttons, the block on EC 602-... must not be activated for the other factors.
- Two time profiles are possible with the input block: "Around the clock access" and access times controlled by timer

Event	Block with input 1 (checkbox)	Input 1 (E1/E0 jumper)	Description
Valid factor (code, RFID card/RFID tag, fingerprint)	–		Function is triggered
	✓	Open	Function is not triggered
	✓	Closed	Function is triggered

8.3 Operation with entrance controller EC 602-...

Internal key button

A key button is fitted to the input field of the code lock module. This internal key button can be activated via the E2 switching input on the EC 602-... The key buttons are only functional when the E2/E0 contact is closed. The door release function is only triggered if the EC 602-... is programmed to switch the switching output associated with the door.

External key button

A separate button can be connected on the code lock module and on the display call module, via which the door release can be controlled (external key button). The button function is activated via the switching input E2 on the EC 602-... The key buttons are only functional when the E2/E0 contact is closed. The door release function is only triggered if the EC 602-... is programmed to switch the switching output associated with the door.

Remarks

- It is possible to permit access via key buttons only at certain times by using a timer.
- The input block on the EC 602-... (E1/E0 jumper) can also be activated for the key buttons. In this case, the door release function is only triggered when pressing the key button when both switching inputs are closed.

Event	Block with input 1 (checkbox)	Input 1 (E1/E0 jumper)	Input 2 (E2/E0 jumper)	Description
Internal key button			Open	Button is not accepted Function is not triggered
			Closed	Button is accepted Function is triggered
	✓	Open	Closed	Button is not accepted Function is not triggered
	✓	Closed	Closed	Button is accepted Function is triggered
External key button			Open	Button is not accepted Function is not triggered
			Closed	Button is accepted Function is triggered
	✓	Open	Closed	Button is not accepted Function is not triggered
	✓	Closed	Closed	Button is accepted Function is triggered

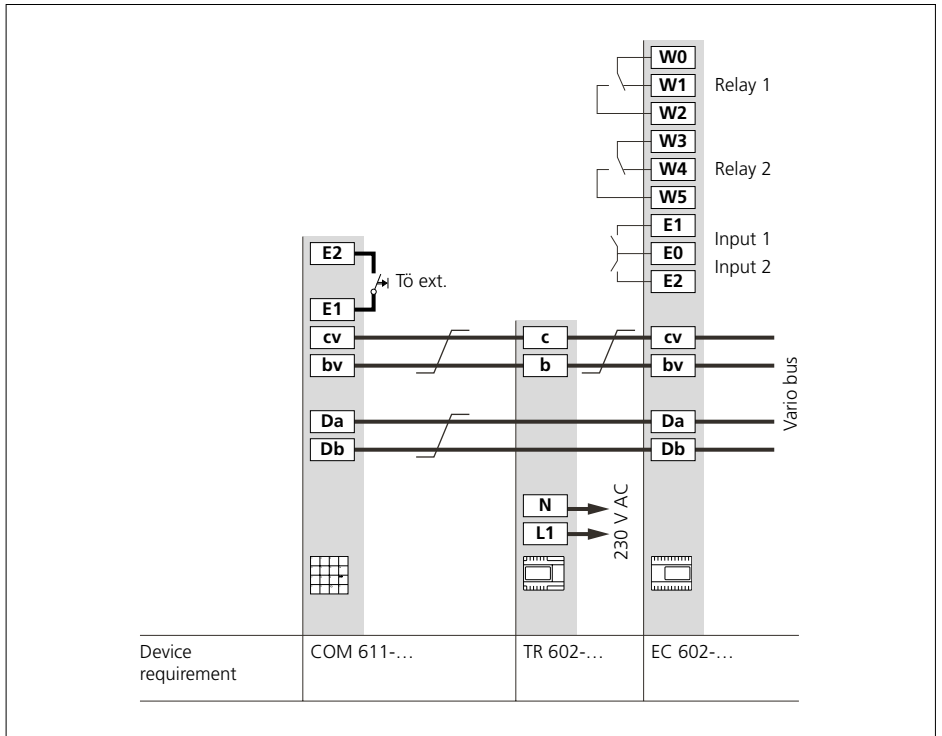

Connection of external key button on EC 602...

8.3 Operation with entrance controller EC 602-...

Gateways / Cascade control for 2 door releases

The gateway function enables a time-controlled switching sequence for two relays (doors) / switching contacts in any order.

A gateway function must be programmed for each throughput direction through a gateway.

In the case of gateways for which there is an incoming throughput direction as well as an outgoing throughput direction, two gateway functions must be programmed (e.g. incoming: gateway A with switching sequence: switching contact 1, 2 and outgoing: gateway B with switching sequence: switching contact 2, 1).

2 relays are needed for each gateway function.

The relay assigned to the 1st position in the switching sequence (e.g. switching contact 1) always switches first. After a specific pause time, the relay assigned to the 2nd position (Out2) switches (e.g. relay 2). After the set gateway delay time, the relay assigned to the 2nd position (switching contact 2) switches.

The gateway delay time corresponds to the pause between the activation of switching contact 1 and switching contact 2.

The relay configuration (local/global) affects the input/read units authorised to trigger the gateway:

With the EC 602-..., max. 2 gateways (A, B), can be used, together with the ECE 602-... max. 4 gateways (A, B, C, D) can be used.

Example switching sequence

	Defined switching time	Switching sequence
Switching contact 1	3s	3s
Gateway delay time	6s	6s
Switching contact 2	3s	3s

Relay configuration

Relay [x] 1st position	Relay [y] 2nd position	Gateway triggering
Local	Local or global	Through all input/read units with the same Vario bus address as the 1st position relay
Global	Local	Through all input/read units with the same Vario bus address as the 2nd position relay
Global	Global	Through all input/read units via which the correctly assigned code, RFID card/RFID tag or fingerprint is entered

Feedback input on COM 611-...

Upon request, further switching contacts can also be operated via code with the EC 602-... as well as the door, for example a customer-provided outside light, an alarm system or a silent alarm.

The installed LED on the COM 611-... code lock module can be used as a feedback input here, e.g. as a status indicator for an (armed) alarm system.

Connection takes place via terminals L1 and L2 (potential-free input).

Note

The LED is only installed in the Vario design code lock module. The Steel and Classic design lines do not have a feedback input.

8.4 Operation with Secure Controller SC 600-...

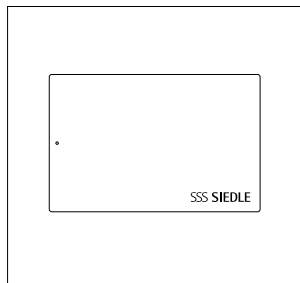

The SC 600-... Secure Controller networks up to 4 doors.

If more than 4 doors are to be networked, this can be achieved with additional SC 600-... or SE 600-...

One SC 600-... can be extended with up to 2 SE 600-...

Secure Extensions. Thus, 1

SC 600-... + 2 SE 600-... can control

up to 12 doors. A maximum of 64

SC 600-... can be networked with

one another via LAN. Therefore, in

total up to 768 doors can be con-

trolled in the group.

The SC 600-... is a central element

for controlling the Siedle access

control:

It is used as an electronic evaluating

circuit and switching unit in conjunc-

tion with the code lock module and

the electronic key reading module.

The SC 600-... also enables time

profiles to be created for different

access groups and users.

The SC 600-... is operated directly

via a PC network (Ethernet standard

10/100 Mbit). It is operated using a

browser, current version.

The SC 600-... can be programmed

using an up-to-date browser.

Detailed information about program-

ming can be found in the SC 600-...

commissioning instructions.

9 Glossary

Code

Series of digits that must be entered to gain access from a controller.

Made up of 1 to max. 8 digits (1 – 99,999,999).

Up to 99 codes (each max. 8 digits) can be programmed on the EC 602-... entrance controller. There is no limit on the SC 600-... Secure Controller.

It is not possible to assign codes twice.

COM 611-...

Code lock module as input unit for access control and for making door calls.

Digital call input

Only in conjunction with a door communication system.

An alternative to calling via the call buttons; the door call is made via an input unit (e.g. COM 611-... code lock module or the DRM 612-... display call module).

Connected telephones are called via a call number which is either entered directly (COM 611-...) or selected from an electronic list of names (e.g. DRM 612-...).

EC 602-...

Entrance controller in switch panel housing for code lock module, electronic key reading module or fingerprint module.

Input unit

Module for entering factors in conjunction with the Siedle access control, e.g. COM 611-...

Input block

The input block is the option to suppress triggering of the door release upon entry of a code, RFID card/RFID chip at specific times. This means that access via factor can be blocked at weekends or at night, for example.

With the EC 602-... the input block is implemented via switching input E1/E0.

In the case of the SC 600-..., access is controlled via user groups, time profiles and week programmes.

Individual operation

see Stand alone operation

EK... (RFID tag / electronic key)

Electronic key in conjunction with the electronic key reading modules.

This is used to open a door or trigger a function in conjunction with the ELM... electronic key reading module.

EKC... (RFID card)

Electronic key card in conjunction with the Siedle electronic key reading modules.

This is used to open a door or trigger a function in conjunction with the ELM... electronic key reading module.

ELM...

Electronic key reading module as a contactless access control system with LED function.

The ELM 600-... offers increased security via MIFARE DESFire EV2 compared to the ELM 611-... The ELM 600... can only be used in conjunction with the EKC 600-... cards and the EK 600-... keys.

External key button

see Key button, external

Fingerprint

Factor that is used to open a door or trigger a function in conjunction with the FPM 600-... fingerprint module.

The fingerprints are stored directly in the fingerprint module.

A maximum of 100 user fingerprints can be managed in the system.

FPM 600 -...

Fingerprint module as access control system with function LED.

Internal key button

see Key button, internal

Read unit

Module for reading in factors in conjunction with the Siedle access control, e.g. ELM...

Features

Factors are codes, RFID cards/RFID tags or fingerprints. These can be used to trigger a function, normally the door release.

In conjunction with the SC 600-... Secure Controller, factors are assigned to specific people so that evaluation (e.g. attendance list) is possible.

PRS

PRS 602-... programming software for setting up access control with the EC 602-...

Download at www.siedle.de

Key button, external

Separate button which can be connected to the code lock module so it can be used to trigger the door release function.

An external key button can only be used in conjunction with a controller (EC 602-... or SC 600-...).

9 Glossary

Key button, internal

A key button is fitted to the input field of the code lock module for triggering the door release function. The internal key button can only be used in conjunction with the EC 602-... entrance controller.

Key cards

see EKC...

Security block

Input block which is activated after the 10th unsuccessful attempt to gain access with an incorrect code or unauthorised RFID card/unauthorised RFID tag.

The disable time is programmed in the EC 602-... entrance controller or the SC 600-... Secure Controller.

The blocking intervals for EC 602-... are 1 minute, 5 minutes, 30 minutes, 1 hour, then a continuous block.

In the case of the SC 600-...

Secure Controller, the duration of the disable time can be freely selected in seconds, as well as the maximum number of mis-entries per door.

Block mode

see Security block

Stand alone operation

Operation without controller. Is also called individual operation.

Evaluation takes place in the module itself.

Access to exactly one door is controlled. The switching contact for the door release is located in the module. The door can either be opened via ELM... or FPM 600-...

A COM 611-... cannot be used in stand-alone operation.

SC 600-...

Secure Controller as the central controller for managing access rights in private buildings and commercial properties.

SE 600-...

Secure Extension as an extension for the Secure Controller. Up to 4 Extensions can be connected per Controller.

DR button

see Key button, external or Key button, internal

Vario bus

The Siedle Vario bus is the interface between the input/read units and the evaluating unit/the controller.

There are currently two controllers

for evaluation for the Vario bus:

- Entrance controller EC 602-...
- Secure Controller SC 600-...

Time profiles/weekly programmes

(only with SC 600-...)

The time profile/week programme determines the times and days when a user or a user group is granted access.

The start and end time per weekday/public holiday can be specified for each time profile/week programme. Several start/end times can be assigned to each day.

Likewise, an individual time profile/week programme can be defined for each individual door.

Access control

Access control ensures that only authorised persons can enter certain areas. Depending on the expansion stage, time profiles are available which determine when a person can access the area in question, as a further access restriction.

In Vario bus operation, the access control is centrally controlled via a controller (EC 602-... entrance controller or SC 600-... Secure Controller) which can manage 8 or 4 doors respectively.

In a group of up to 64 SC 600-... and 128 SE 600-... up to 768 doors can be controlled.

A door can be secured with a code lock or an electronic key module. When a valid factor is entered, the controller switches a relay, which controls a door release, a revolving door or turnstile, for example.

Access control system

An access control system consists of at least three components:

- A sensor (input/read unit)
- An actuator (door release, gateway or similar)
- A set of rules "WHAT-WHEN-WHERE"

The "WHAT-WHEN-WHERE" set of rules is used to define which persons have access rights to which areas.

The access rights can be time-limited (expiration, time).

10 Symbols used and their meaning



Stand-alone/individual operation
(operation without controller)

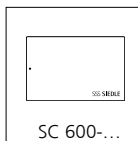

Operation with Secure Controller
SC 600-...

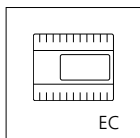

Operation with entrance controller
EC 602-...
Extended with an ECE 602-...
entrance controller extension, if
necessary



Number of the locations in the case
of networked operation of access
control at several locations
(only possible with the SC 600-...
Secure Controller)

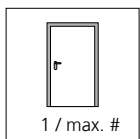

Possible number of normally
open contacts for door release or
another consumer in the system,
e.g. 1 or up to max. 8 normally
open contacts for door release

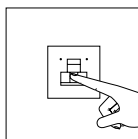

Door release via fingerprint with the
FPM 611-... fingerprint module

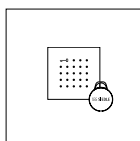

Door release with RFID card/
RFID tag (electronic key) via the
ELM 600/611-... electronic key
reading module

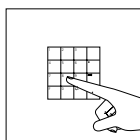

Door release by entering a code via
the COM 611-... code lock module
Code: 1-8-Digits (0-99,999,999)



Possible number of users in the
system, e.g. max. 500 users

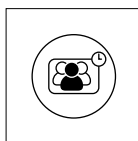

Access can be managed, e.g.
via input block and time profiles
(EC 602-...) or via access groups and
time profiles (SC 600-...)

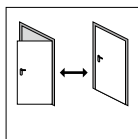

Gateways possible in system
(gateway = establishment of cascade
control for 2 door releases)

11 After-sales service



Qualified contacts are on hand to offer a fast, professional service. By telephone, or if required we will be pleased to visit you on site. Customers and sales partners outside of Germany should contact one of our international representatives.

The current overview broken down according to regions is located in the download area on www.siedle.com/ contact

Furtwangen plant

Service hours:
Monday through Thursday from
7.30 a.m. to 5.00 p.m.
Friday up to 4.00 p.m.

Order processing

Tel. +49 7723 63-451
Fax +49 7723 63-72451
offers@siedle.de

Technical hotline

Tel. +49 7723 63-434
Fax +49 7723 63-72451
offers@siedle.de

Quotation processing

Tel. +49 7723 63-477
Fax +49 7723 63-313
angebot@siedle.de

SSS SIEDLE

S. Siedle & Söhne
Telefon- und Telegrafengeräte OHG

Postfach 1155
78113 Furtwangen
Bregstraße 1
78120 Furtwangen

Telefon +49 7723 63-0
Telefax +49 7723 63-300
www.siedle.de
info@siedle.de

© 2020/02.23
Printed in Germany
Best. Nr. 210012218-00